

Modular Presentation Systems

for counter
and buffet

Durable products
Consulting & counter planning
Individual manufacturing



MEAT
DELICATESSEN
CHEESE
FISH
SNACK
CATERING



reddot winner 2025





A new desire for pleasure

The art of conscious, mindful eating is finding more and more followers. So is the idea of not living today at the expense of tomorrow. For us as developers of modular presentation systems, sustainability is a cornerstone of our philosophy.

In times of changing consumer behavior, it is crucial to present good food in the right way. From **food retailers** to **butchers** to **restaurants**, many industries are looking for strategies to find and retain new customers and guests.

An attractive presentation of your culinary delicacies is crucial for success. It attracts your target group, arouses curiosity and tempts them to try your products.

Our recommendation for your fresh food counter: **modular systems in the presentation of goods** that promote communication points to people. They support a targeted design that can be changed quickly and flexibly to suit your inventory and processes – because the arrangement system is intuitive and easy for your employees to handle without prior knowledge.

Living sustainably: Our durable products, manufactured in Germany, and a new, eco-friendly company facility make us fit for the future. The most recent **innovations in our line of approximately 1,200 products** include organically shaped bowls and plates as well as additional surfaces.

Sincerely

Christian Priebe
Managing Director PricoPlex

We have recently published „**The 10 Rules of sales-promoting counter presentation**“ in the trade press. You too can benefit from our tips for your sales – simply send an e-mail to office@pricoplex.com with the keyword „10 rules“ or request it online:

www.pricoplex.com



CONSULTING



COUNTER
PLANNING



DURABLE
PRODUCTS



EXPERIENCE
SINCE 1954



MADE IN
GERMANY

PRICOPLEX	Page
Company	04
Sustainability	05
Production	06
Quality & Durability	08
Product highlight: Patented Honeycomb-Buttom	10
Colors & Surfaces	12
Modular System	14
Full Service:	
Consulting	16
Counter planning	18
Individualizations	20
Product ranges & industries	22



Our modular system makes it all work.

More about this on page 14/15.

PRODUCTS

Tableware for counter, catering and buffet	26
Trays and Deep Trays	40
Stepped Displays	86
Salad and Deli Trays	92
Layered Curved Displays	104
Circular Turntable Displays	110
Deep Tray Combis and Angle Solutions	116
Decor Panels and Inserts for Stepped Displays and Counter floor	122
Counter Tops	124
Counter Accessories	132
General terms and conditions	136
Order form	137
Contact	139

We show the best side of food

We at PricoPlex promote the demand for fresh food. For this purpose, we develop modular counter systems and modern tableware with extremely long service life. This makes us a reliable partner in the field of professional food presentation.

As an interior designer for the fresh food counter and supplier in the tableware sector, we produce flexible presentation systems for leading food professionals. We are committed to sustainability in all aspects of production and manufacture directly in Germany.

Whether Display Tray, Display Deep Tray or Counter Top: Our products are impact resistant, easy to clean and even recyclable. Their modular character guarantees optimal space utilization. We offer individual plans for near 100 percent use of your display space.



SUSTAINABILITY

Focus on long product cycles and resource conservation



Christian Priebe
Managing Director

For us, this means sustainability: innovative product policy, conscious use of resources, energy and raw materials, responsibility for people and nature, and a long-term after-sales guarantee. For a positive and successful future for you and your/our industry.



TRACEABLE PRODUCT PATH

From raw materials to production and disposal management - we rely on transparent paths for each individual development step. In this way, we guarantee consistently high quality and safety for all partners.



SAVE RAW MATERIALS AND PROTECT RESOURCES

Sustainability is deeply rooted at PricoPlex. The high-performance plastics we utilize have a long service life, and 50 percent of the raw materials are produced with the help of green electricity. Saving resources and allowing low-emission production of our products.



MANUFACTURING IN GERMANY

We produce using injection molding and vacuum thermoforming processes in Bavaria. This means we can rely on high-quality ingredients, good working conditions and compliance with environmental regulations. The production process is primarily based on green electricity.



EXTREMELY LONG SERVICE LIFE

The average life of our plates and Trays for professional food presentation is significantly longer than similar products. The materials we use are break and shock-resistant and suitable for cleaning in the dishwasher.



GREEN HEAD OFFICE

Emissions reduced at the site: Our company building is fed by geothermal energy and our in-house PV system. The green roof filters the air, can temporarily store water and provides cooling and insulation for the offices.



ACTIVE RECYCLING MANAGEMENT

Unlike other plastics on the market, the materials we use can be recycled. For this purpose, we offer to reliably return your discarded products to the raw material cycle.

From the raw material source to the production process, service life and disposal management, our plastics meet the requirement to be sustainable.



INJECTION MOLDING



THERMOFORMING

PRODUCTION

Best raw materials sourced under strictest controls for quality products

Sourcing and processing as a top team: We obtain our raw materials from competent development partners. The carefully controlled production takes place in the production facilities of a German family-owned company.

Depending on the requirements of the respective product, we use two different manufacturing processes: In the deep-drawing process, the elements are drawn into the shape of hollow bodies. In the injection molding process, granules are injected into a mold under high pressure. The result: extremely dimensionally stable parts in particularly efficient production – this is how raw materials are used sensibly.



MANUFACTURING PROCESS

- ✓ Raw material conservation
- ✓ Very high strength
- ✓ Effective use of materials
- ✓ Complex shapes possible
- ✓ High process control

SUSTAINABILITY

-  We consciously rely on technically high-quality and recyclable materials.
-  Production residues are recycled back into the production of raw materials as part of a sustainable, circular economy.



More about the manufacturing process of PricoPlex at

www.pricoplex.com

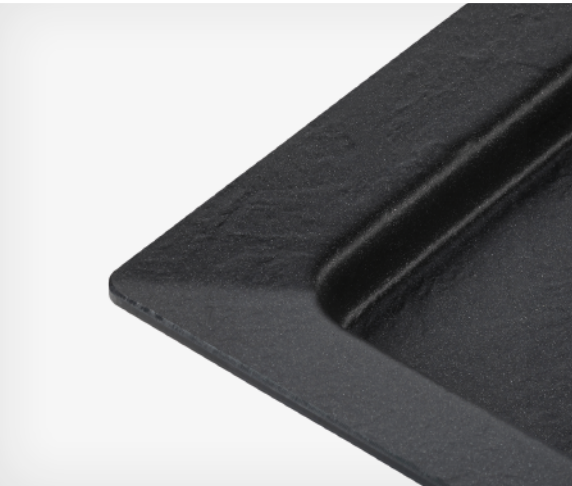
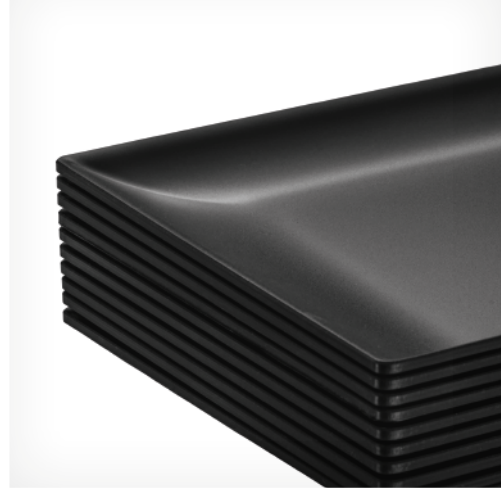
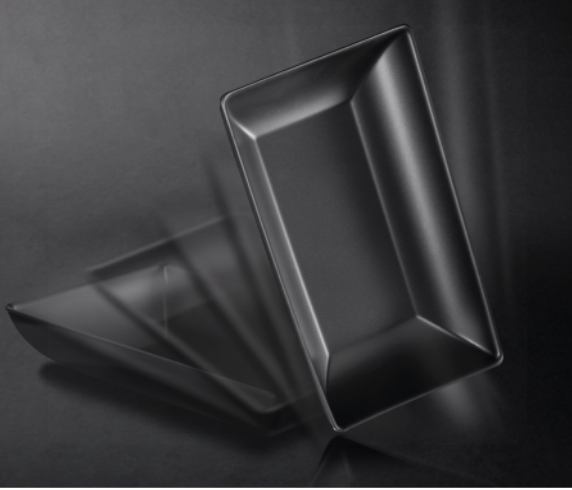

REQUEST PRODUCT SAMPLE NOW

Feel the difference

Just feel the sample - because not all plastics are the same. The robust surface of our unbreakable Display Trays can be clearly felt. Reserve your product sample now! Short mail to:

office@pricoplex.com

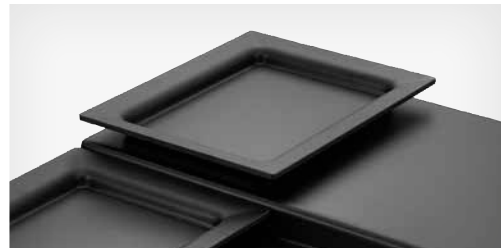

QUALITY & DURABILITY

Highest quality and functionality from the beginning

Fresh and quality food should be presented in a high-quality manner. This is achieved particularly effectively with products made of our robust plastic, as they guarantee the highest visual appeal and best service life.

Our unbreakable counter and buffet equipment in the flexible modular system is available in expressive shapes, colors and surfaces. Since our foundation in 1953, we have optimized both the selection of materials and processing methods, relying on modern manufacturing in Germany. The result: easy-to-clean and at the same time very robust and optically appealing solutions.



THE MATERIAL

-  food safe
-  impact and breakage resistant
-  easy to clean
-  dishwasher safe
-  marinade resistant
-  temperature resistant
-20° to +85°C
-  recyclable

YOUR ADVANTAGES

- ✓ Sustainable through longevity
- ✓ Best materials and workmanship
- ✓ Attractive surfaces
- ✓ Stackable to save space
- ✓ Modular combination options
- ✓ Long-term repurchase guarantee



Leading food professionals rely on quality from PricoPlex:



and many more

EXPERT TIP



Rainer Koch
PricoPlex
Customer Consultant

“The Honeycomb-Bottom Insert prevents discoloration of the meat over a long period of time. For beef, according to customers, this is about 72 hours. This means you can offer the meat fresh for much longer. This is particularly sustainable, saves time and, of course, money.”



PRODUCT HIGHLIGHT

Patented Honeycomb-Bottom Insert as a freshness kick for your meat presentation

You're probably familiar with this: When meat sits in the deli counter for a long time, it develops a gray underside. To prevent this, we have developed special patented Honeycomb-Bottoms. In this way, the meat is also ventilated from below.

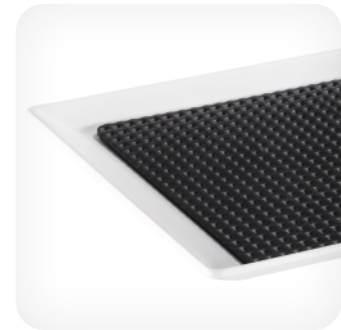

A welcome side effect is that small amounts of escaping meat juice are no longer visible with this technology. If your Display Trays and Deep Trays are equipped with Honeycomb-Bottoms, there is no longer any need for a paper insert. In terms of color design, Honeycomb-Bottoms can either be „tone in tone“ or provide a color contrast. For visible freshness and an effective workday.



YOUR ADVANTAGES

- ✓ Natural meat color remains intact
- ✓ Optimized storage
- ✓ Escaping meat juice disappears and enables an appetizing presentation
- ✓ Dishwasher safe

SUSTAINABILITY

-  Steak paper inserts are eliminated, thus waste is consistently avoided
-  Reusable again and again



EXPERT TIP



Michael Keller
Master butcher,
meat sommelier and hunter

Best quality is recognizable at first glance:
High-quality meats are immediately recognizable
as such when presented on elegant platters. A
Slate or Wood look, for example, is ideally suited
for regional and international specialties.

GLOSSY COLORS:



black glossy
-02

white glossy
-10

green glossy
-04

red glossy
-05

yellow glossy
-06

**champagne
glossy**
-12

COLORS & SURFACES

Optical contrasts for the differentiation of product groups and more

Do your product groupings contain individual products or subgroups with different origins or a range of qualities? This is usually difficult for non-professionals to recognize. Use our color selections to easily distinguish product groups – e.g. green for organic products.

MATTE COLORS:



TRANSPARENT COLORS:

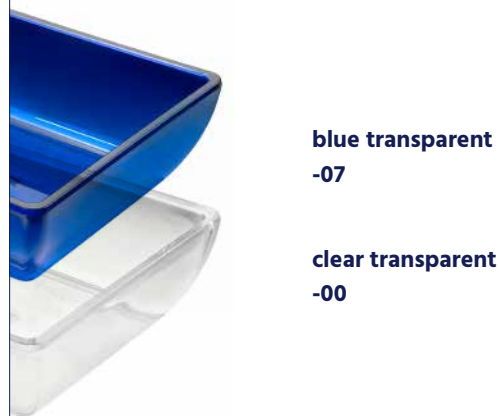

SURFACES WITH TEXTURE:





EXPERT TIP



Fritz Gempel
Management consultant
and master butcher

A skilful mix of clear lines and targeted visual interruptions are the optimum in the fresh food counter. Once it has been thought out, every store can have the same layout.



Added value through System equipment

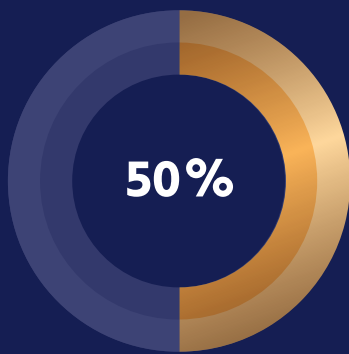

Stimulate Spontaneous Purchases

Half of all purchasing decisions in retail are made spontaneously on the spot. Stimulate them with an attractive presentation of goods!

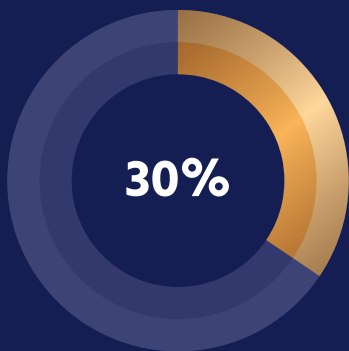

Create time savings

Save around one third of your service time at the counter. Guide your customers through your assortment with a targeted design!

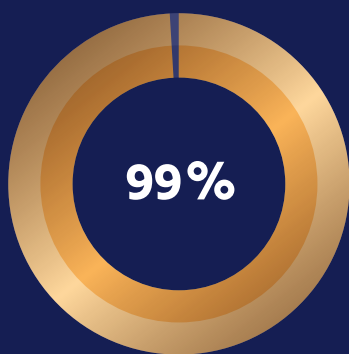

Counter utilization use

With our individual counter concepts you create a nearly 100 percent utilization of your counter.

Tried-and-tested measures are required to boost demand at the fresh produce counter in a targeted manner. An adaptable counter design guides your customers through the assortment, emphasizes high-margin products, and arouses curiosity about new products or specialties. Offers attract customers to brick-and-mortar stores – on-site sales drivers should be enchanting.



Analysis of the current state of your counter



Concept for flexible Modular system



Setup and Consultation on site



“Modular plans for counter occupancy create flexibility and save time.”

Christian Priebe
PricoPlex
Managing Director

CONSULTATION

Needs assessment and analysis of current situation from counter planning to on-site support

Full service is written in capital letters at PricoPlex. As specialists in professional food presentation, we have offered first-hand knowledge of the needs behind the fresh food counter for more than 50 years. With a custom-made system, we equip your counter functionally, attractively and economically. Your fresh food counter is as unique as your goods. That is why we listen carefully to what is important to you in counter sales. This allows you to set targeted priorities while ensuring order and focused planning. Another important factor: More functionality reduces work steps.

YOUR ADVANTAGES

- ✓ Demand-oriented concept
- ✓ Individual product range support
- ✓ Modular system equipment
- ✓ Customized production as required
- ✓ Delivery and furnishing

Arrange a consultation appointment now!

Phone at:

+49 (0) 81 93 – 23 69 80

Book online appointment at:



Simply scan via smartphone and select appointment!

Get a free counter plan and get advice.



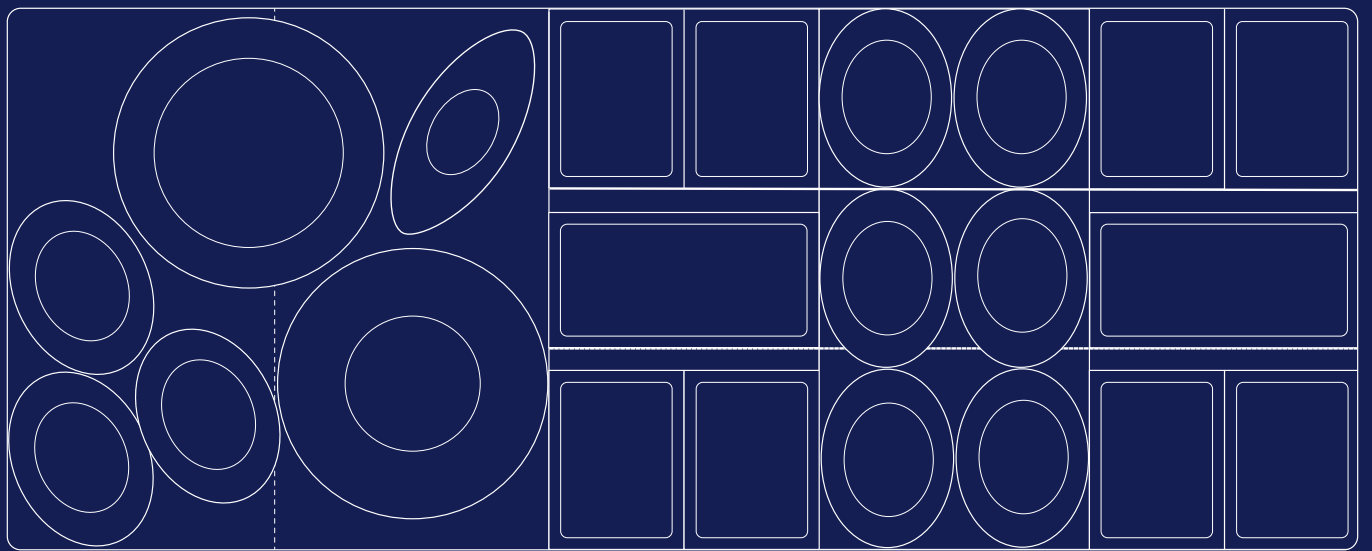

COUNTER PLANNING

Actively guide through the assortment with an individual counter plan

Are you wasting valuable presentation space in your deli counter? Do you know the problem of filling quantities – small product in too-large Trays or a lot of product in too-small Trays? Do you want to fill spaces where regular products do not fit? We equip your counter with the most attractive solution: clear lines and more variety in the same space.

- ✓ Structured appearance
- ✓ Targeted assortment management
- ✓ Optimal space utilization
- ✓ Flexible modular system
- ✓ Individual customization

1



Personal advice with competence

Every year, we advise on around 700 new openings and redesigns in specialist butchers' stores and food retailers. We show you how to optimally create dense product presentations.

2



Counter planning according to your needs

Presentation of sales drivers, sales of fresh goods over the course of the week, presentation of new products, regional differences in consumer behavior - your counter plan takes all requirements into account.

3



On site facility

On request, we can equip your fresh food counter with the new system layout, explain handling and cleaning, demonstrate the wide range of combinations and give tips on how to increase demand.

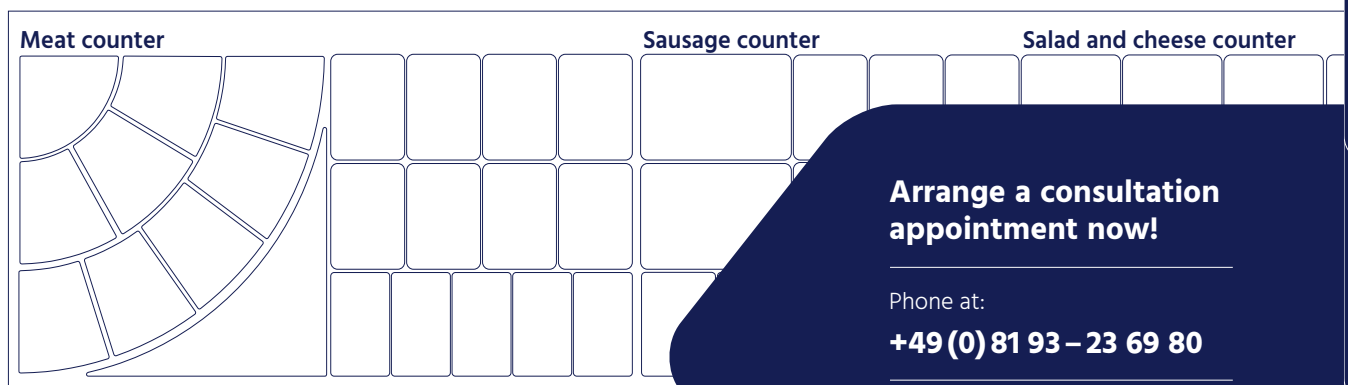

Arrange a consultation appointment now!

Phone at:

+49 (0) 81 93 – 23 69 80

Book online appointment at:



Simply scan via smartphone and select appointment!

Make an appointment and have your individual counter plan created!

Whether counter or buffet, table or board – everything individually presented

We design and manufacture according to your specifications, customizing products according to your specific requirements – in the shape you want, the color you want and even with your company logo. Take advantage of our creativity and many years of experience in product development. We will advise you, set schedules, guide you through the entire process and check each development phase for quality.

Original design manufacturing

PricoPlex designs and manufactures according to your specifications. Thus, customized products can even be implemented individualized with your own logo. With creativity, our many years of product development know-how and with the best production resources, we guide you through the process and coordinate the individual development phases from your requirement to your finished product.



IDEA

It all starts with a basic idea. Thanks to our team, you refine it down to the last detail - tailor-made, individual, creative.

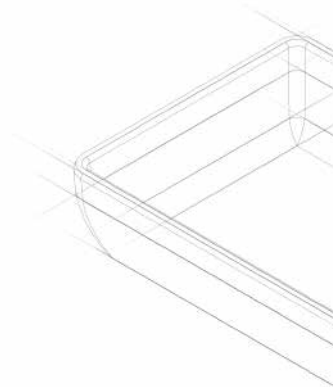

DESIGN

A CAD drawing of your future product provides the final design. We define shapes, colors and surfaces visually.

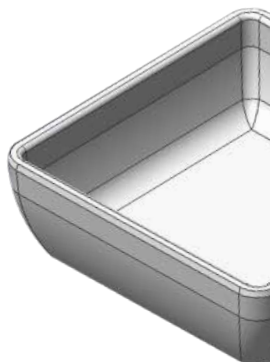

PROTOTYPE

In 3D printing we produce a prototype, which you receive for approval. Now material and manufacturing technology is defined.



FINISHED PRODUCT

Your product is covered by the PricoPlex quality guarantee-whether a small or large series, whether with your company logo or blank.



Small batch Series production

Do you need a Display Tray or Display Deep Tray in a specific design, e.g. for individual solutions in the corner? Do you need an exciting presentation idea for new product groups that you want to introduce? We manufacture your individual Series in the desired quantity – let us advise you.

Branding

Your company logo or a specific unique selling proposition (e.g. „Homemade“) attached directly to the product ensures more attention at your fresh food counter or buffet. We create individual branding using laser technology.

Customized

For every corner and every angle of your counter: You want an individual solution according to your desired dimensions? Feel free to contact us, because individual solutions are our competence.



Make a consultation appointment with one of our customer consultants now to learn more about suitable solutions or to make a plan.

Phone at:
+49 (0) 81 93 – 23 69 80

Book online appointment at:



Simply scan via smartphone and select appointment!

With a diverse range appeal to all senses and whet the appetite for more

Whether at the meat counter, the snack counter or in catering: different product areas have individual requirements for food presentation. Our modular presentation system takes into account all product areas together with their specific characteristics: Fresh fish on ice, liquid marinades, small delicatessen specialties, large cheese wheels, delicately sliced ham, salads to go and much more.

Many of our products can be used in any range of goods. We will be happy to work out the right solution for any assortment and offer the appropriate recommendation based on our many years of experience.

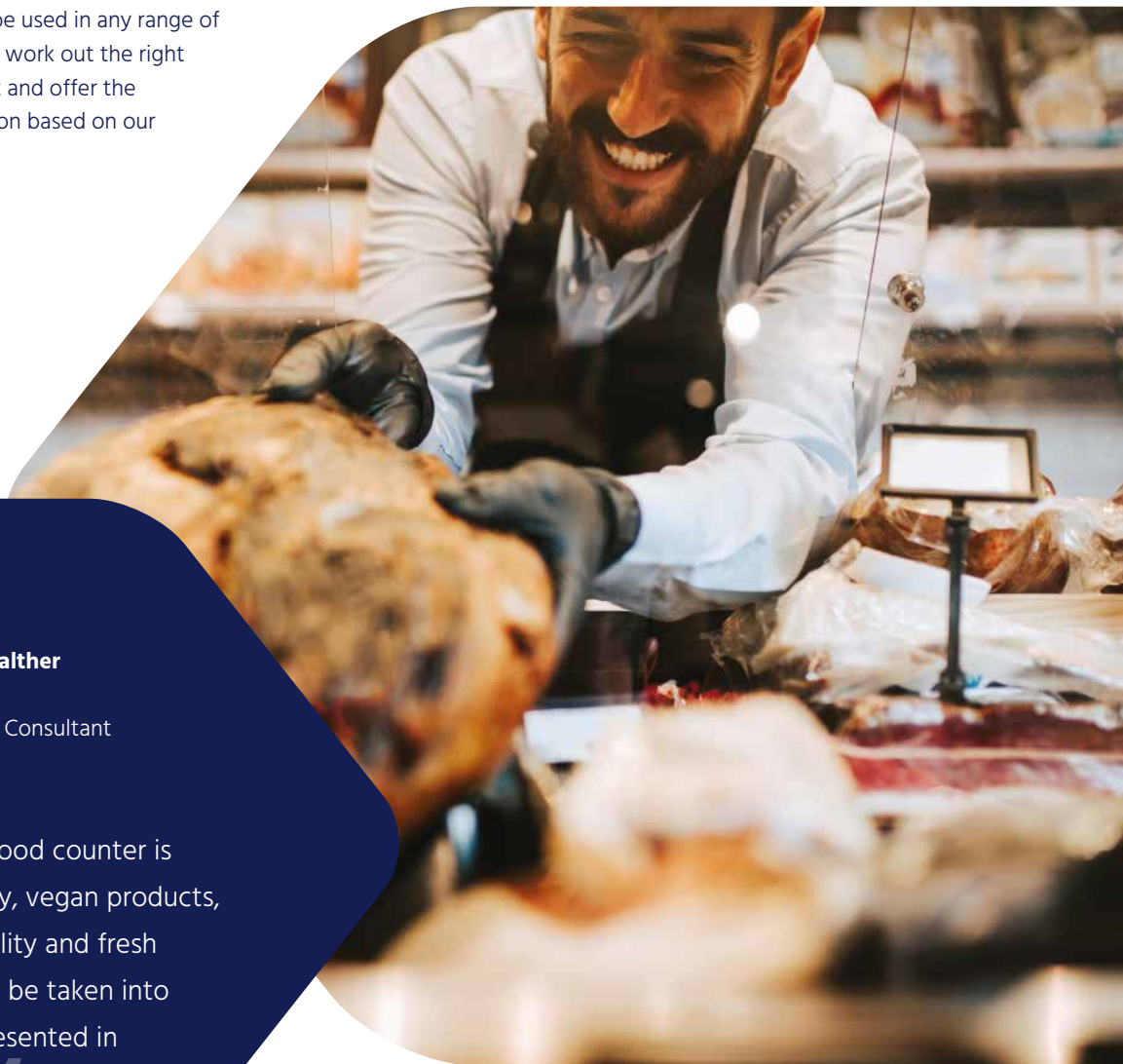

EXPERT TIP



Daniel Walther
PricoPlex
Customer Consultant

“Demand at the fresh food counter is changing: sustainability, vegan products, delicatessen, high-quality and fresh snacks – all this has to be taken into account today and presented in the appropriate garb.”



MEAT COUNTER



SAUSAGE COUNTER



CHEESE COUNTER



FISH COUNTER



SALAD AND DELICATESSEN COUNTER



VEGAN COUNTER



SNACK COUNTER



CATERING

Accessories | Counter Tops | Decor Panels & Inserts | Tray Combs & Angle Solutions | Circular Turntable Displays | Layered Curved Displays | Salad & Deli Trays | Stepped Displays | Trays & Deep Trays | Tableware

Complete assortment at a glance

	Page
Tableware for counter, catering and buffet	
Series CLAY	26
Series REED	28
Series CUT	30
Series FLOW	32
Series SWUNG	34
Series CATE	36
<hr/>	
Trays and Deep Trays	
Series GRACE	40
Series FRESH	48
Series NEO	72
Series ECO	80
<hr/>	
Stepped Displays	86
<hr/>	
Salad and Deli Trays	
Series CASUAL	92
Series FRAME	98
Series FRESH	102
<hr/>	
Layered Curved Displays	104
<hr/>	
Circular Turntable Displays	110
<hr/>	
Deep Tray Combis and Angle Solutions	116
<hr/>	
Decor Panels and Inserts	
for Stepped Displays and Counter floor	122
<hr/>	
Counter Tops	128
<hr/>	
Counter Accessories	132

THE TRENDSETTER SEDUCTION

Tableware Bowls Series CLAY



Want a taste? The round bowl CLAY is based on the high-quality gourmet plates used in presenting the finest cuisine. Unique, attractive, approachable – trendsetters are trendsetters, and trendsetters attract.

YOUR ADVANTAGES

- ✓ Natural design language
- ✓ Reinforces the character of freshness
- ✓ Unifies the elements of a display or table
- ✓ Matte surfaces:



Dimensions in mm (LxWxH)	200 x 200 x 50	270 x 270 x 60	400 x 400 x 75
Volume	1.000 ml	2.000 ml	5.500 ml
Item no.	CLAY200200-50	CLAY270270-60	CLAY400400-75
graphite stone -25	€ 21,95	€ 27,95	€ 46,95
petrol stone -28	€ 21,95	€ 27,95	€ 46,95
white matt -70	€ 21,95	€ 27,95	€ 46,95
black matt -72	€ 21,95	€ 27,95	€ 46,95

Please add the color coding to the article number when ordering!

Prices plus VAT.

TIPS & TRICKS

From the cheese or sausage specialties to the colorful delicatessen salad. A simple, expansive design that fits perfectly between modern country house style and trendy Scandi look, suits any display.

FOR SPECIALTIES FANS

Tableware Bowls Series REED



With these clear lines, your customers will dream of selected delicacies and exceptional recipes. The bevelled edges of the REED bowl enhance the effect – because high quality must be made visible.

YOUR ADVANTAGES

- ✓ Sleek and Elegant
- ✓ Adds a noble touch
- ✓ For decorative presentation
- ✓ Matte surfaces:



Dimensions in mm (LxWxH)	200 x 200 x 55	270 x 270 x 60	400 x 400 x 65
Volume	900 ml	1.500 ml	4.000 ml
Item no.	REED200200-55	REED270270-60	REED400400-65
graphite stone	 -25 € 21,95	€ 27,95	€ 46,95
petrol stone	 -28 € 21,95	€ 27,95	€ 46,95
white matt	 -70 –	€ 27,95	€ 46,95
black matt	 -72 –	€ 27,95	€ 46,95

Please add the color coding to the article number when ordering!

Prices plus VAT.



TIPS & TRICKS

Fish and seafood presented on ice: In bowls of different sizes and shapes, they suggest variety and choice. This makes specialties from all over the world seem like an exquisite luxury that you want to indulge in.

TOUCH OF EXOTICISM

Tableware Bowls Series CUT



The filigree display Deep Tray CUT looks like an Asian rice container and stands out particularly well in groups. For visual highlights that deliberately interrupt a conventional arrangement and create a modern ambience.

YOUR ADVANTAGES

- ✓ Modern oval shape
- ✓ Narrow and elongated
- ✓ For diagonal arrangements
- ✓ Matte surfaces:



Dimensions in mm (LxWxH)		300 x 160 x 63	410 x 200 x 63	590 x 210 x 33
Volume		1.000 ml	1.700 ml	1.800 ml
Item no.		CUT300160-63	CUT410200-63	CUT590210-33
graphit stone	 -25	€ 21,45	€ 23,95	€ 27,95
petrol stone	 -28	€ 21,45	€ 23,95	-
white matt	 -70	€ 21,45	€ 23,95	€ 27,95
black matt	 -72	€ 21,45	€ 23,95	€ 27,95

Please add the color coding to the article number when ordering!

Prices plus VAT.

TIPS & TRICKS

Simple, yet at the same time exciting designs for food presentation bring elegance to your fresh food counter and buffet. From novelties to delicacies – an distinctive must-have for highlights.



IN ORGANIC FORMS

Tableware Bowls Series FLOW



A great design language that attracts attention and whets the appetite for more: The FLOW bowl serves your specialties in a visually perfect setting – for restaurant-style arrangements.

YOUR ADVANTAGES

- ✓ Organic oval shape
- ✓ In trendy pasta look
- ✓ Matte surfaces:



Dimensions in mm (LxWxH)	220 x 160 x 70		270 x 200 x 85	
Volume	900 ml		1.600 ml	
Item no.	FLOW220160-70		FLOW270200-85	
graphit stone	 -25	€ 20,95	€ 24,95	
petrol stone	 -28	€ 20,95	€ 24,95	
white matt	 -70	€ 20,95	€ 24,95	
black matt	 -72	€ 20,95	€ 24,95	

Please add the color coding to the article number when ordering!

Prices plus VAT.



TIPS & TRICKS

For an interesting arrangement of your Trays and Deep Trays, you can use stair displays. This creates an exciting 3D effect – more on Page 86.

FOR NEW PRODUCTIONS

Tableware Plates Series SWUNG



Whether as a single piece or in a group: the SWUNG slab cuts a stately figure in any environment. Particularly impressive: the surface structure in Slate look.

YOUR ADVANTAGES

- ✓ Slightly curved and rimless
- ✓ Structured Slate look
- ✓ Perfectly complements FLOW bowl
- ✓ Matte surfaces:

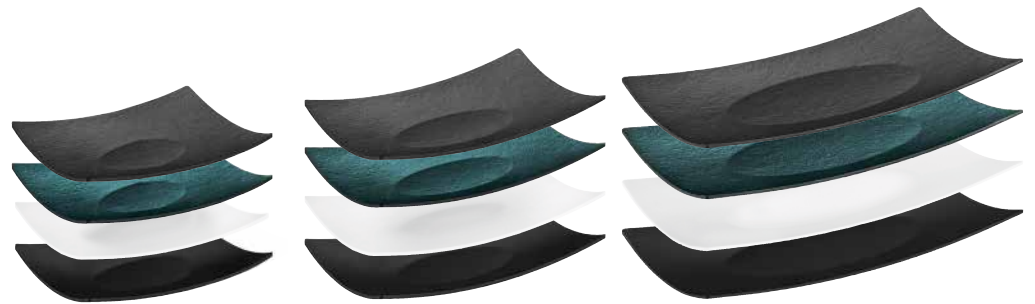

Dimensions in mm (LxWxH)	200 x 160 x 25	270 x 160 x 35	400 x 200 x 35
Volume	–	–	–
Item no.	SWUN200160-25	SWUN270160-35	SWUN400200-35
graphit stone 	-25 € 14,95	€ 17,95	€ 22,95
petrol stone 	-28 € 14,95	€ 17,95	€ 22,95
white matt 	-70 € 14,95	€ 17,95	€ 22,95
black matt 	-72 € 14,95	€ 17,95	€ 22,95

Please add the color coding to the article number when ordering!

Prices plus VAT.



TIPS & TRICKS

Finger food and co. beautifully presented immediately whets the appetite – the exciting combination of your plates in a transverse and longitudinal arrangement becomes an eye-catcher.

PLATES IN GN SYSTEM SIZE

Tableware Plates Series CATE



The CATE series has been specially developed for use in catering and buffets. With CATE, we support you from transportation to serving and cleaning. Cold buffets, from hearty dishes to fish and desserts, are skillfully presented on different colored plates and surfaces.

IHRE VORTEILE

- ✓ All plates available in GN sizes
- ✓ Wide rim for safe transportation
- ✓ Weighs just a quarter of a ceramic plate
- ✓ Dishwasher-safe and easy to clean
- ✓ Robust, hard-wearing material
- ✓ Matt surfaces: 

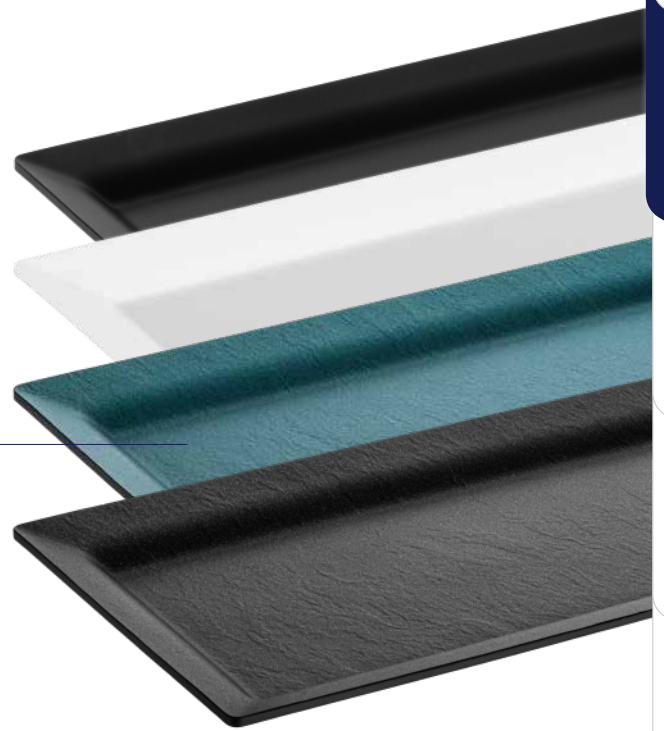

Easy to clean & marinade-resistant

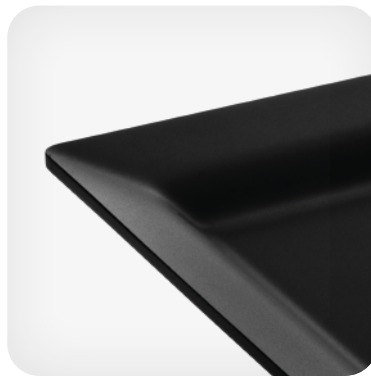

Matt surfaces in various colors

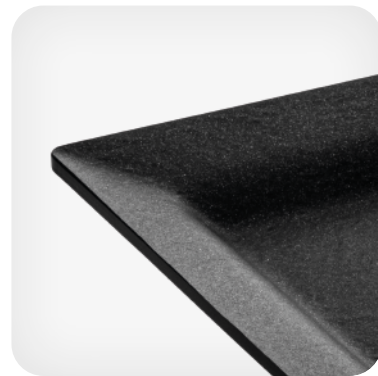

With surface texture (graphite stone)



TIPS & TRICKS

The lightweight plates are easy and safe to carry and the impact-resistant material ensures that nothing breaks during transportation and presentation. After the event, the dishwasher-safe and easy-to-clean plates reduce your workload.

Tableware Plates

Series CATE

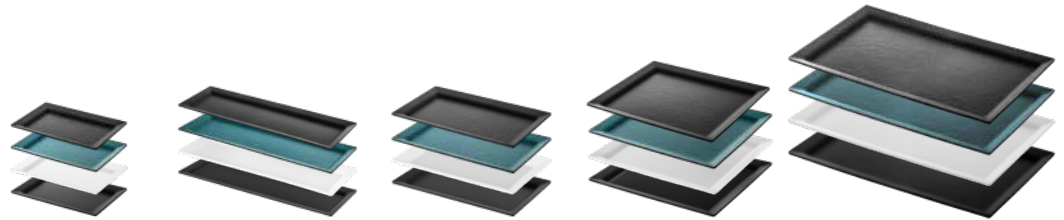

Dimensions in mm (LxWxH)	265 x 162 x 20	162 x 530 x 20	325 x 176 x 20	325 x 265 x 20	530 x 325 x 20
GN	1/4	2/4	1/3	1/2	1/1
Item no.	CAT265162-20	CAT530162-20	CAT325176-20	CAT325265-20	CAT530325-20
graphit stone	-25 € 18,95	€ 29,95	€ 22,95	€ 25,95	€ 44,95
petrol stone	-28 € 18,95	€ 29,95	€ 22,95	€ 25,95	€ 44,95
white matt	-70 € 18,95	€ 29,95	€ 22,95	€ 25,95	€ 44,95
black matt	-72 € 18,95	€ 29,95	€ 22,95	€ 25,95	€ 44,95

Compatible Accessories:

Honeycomb-Bottom Insert	WBC265162-20	WBC530162-20	WBC325176-20	WBC325265-20	WBC530325-20
white matt	-10 € 14,95	€ 20,95	€ 17,95	€ 18,95	€ 22,95
black matt	-72 € 14,95	€ 20,95	€ 17,95	€ 18,95	€ 22,95

Please add the color coding to the article number when ordering!

Prices plus VAT.

CREATING LEVELS WITH STAIRCASE DISPLAYS

With the matching step displays in matt black, glossy black or graphite stone, you can easily create different levels. This makes it easier to remove the food and you can showcase each plate perfectly.

Details can be found on page 87.





EXPERT-TIP



Klaus Wydra
PricoPlex
Customer consultant

To keep your arrangements fresh or to protect them, you can also use the plates as lids.

GRACEFUL DESIGN LANGUAGE

Trays and Deep Trays Series GRACE

with Compatible Accessories





reddot winner 2025



Refined, elegant and developed with the aim of achieving optimum impact across all product areas: from meat to delicatessen to snacks. With this the beautiful design, you create a new look in the counter and can even compensate for low fill levels – the containers never look empty.



YOUR ADVANTAGES

- ✓ Narrow edge for efficient topping
- ✓ Elegant, soft shape
- ✓ For all product groups
- ✓ Compatible with all delivery Trays
- ✓ Also available in Slate look
- ✓ Matte colors:

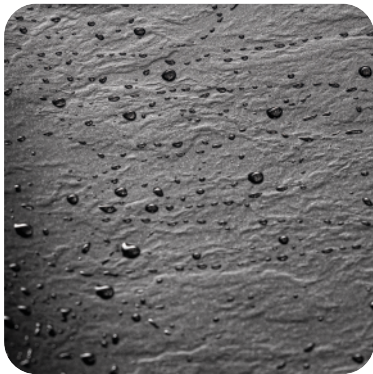

Easy to clean & marinade resistant



Matte surfaces in different colors



With surface structure (graphite stone)

ACCESSORIES FOR SERIES GRACE

Patented Honeycomb-Bottom Insert

- ✓ Preserve the natural color of the meat
- ✓ Replace the use of paper as a base
- ✓ Prevents meat discoloration for up to 72 hours (for beef)
- ✓ Matt surfaces:
- ✓ Glossy surfaces:



You can find more information on Page 10 / 11.



reddot winner 2025



Trays and Deep Trays Series GRACE

with Compatible Accessories

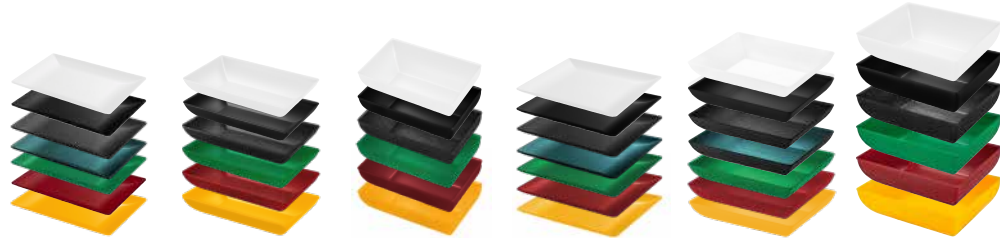

Dimensions in mm (LxWxH)	265 x 160 x 20	265 x 160 x 50	265 x 160 x 80	265 x 200 x 20	265 x 200 x 50	265 x 200 x 80
Volume	-	1.200 ml	2.200 ml	-	1.700 ml	2.700 ml
Item no.	GRC265160-20	GRC265160-50	GRC265160-80	GRC265200-20	GRC265200-50	GRC265200-80
white matt	0 -70 € 18,95	€ 18,95	€ 18,95	€ 22,95	€ 22,95	€ 22,95
black matt	1 -72 € 18,95	€ 18,95	€ 18,95	€ 22,95	€ 22,95	€ 22,95
graphite stone	2 -25 € 18,95	€ 18,95	€ 18,95	€ 22,95	€ 22,95	€ 22,95
petrol stone	3 -28 € 18,95	-	-	€ 22,95	€ 22,95	-
green matt	4 -74 € 18,95	€ 18,95	€ 18,95	€ 22,95	€ 22,95	€ 22,95
red matt	5 -75 € 18,95	€ 18,95	€ 18,95	€ 22,95	€ 22,95	€ 22,95
yellow matt	6 -76 € 18,95	€ 18,95	€ 18,95	€ 22,95	€ 22,95	€ 22,95

Compatible Accessories:

Honeycomb-Bottom Insert	GRCW265160-20	GRCW265160-50	-	GRCW265200-20	GRCW265200-50	GRCW265200-80
white matt	0 -10 € 15,95	€ 15,95	-	€ 16,95	€ 16,95	€ 16,95
black matt	1 -72 € 15,95	€ 15,95	-	€ 16,95	€ 16,95	€ 16,95
green matt	2 -74 € 15,95	€ 15,95	-	€ 16,95	€ 16,95	€ 16,95
red matt	3 -75 € 15,95	€ 15,95	-	€ 16,95	€ 16,95	€ 16,95

Please add the color coding to the article number when ordering!

Prices plus VAT.

HYGIENE TIP

Fulfill hygiene regulations in a simple, practical way with our Panel Divider System. Available for Display Tray and Deep Tray 265 x 200 mm and 400 x 265 mm.

For details, see Page 135.

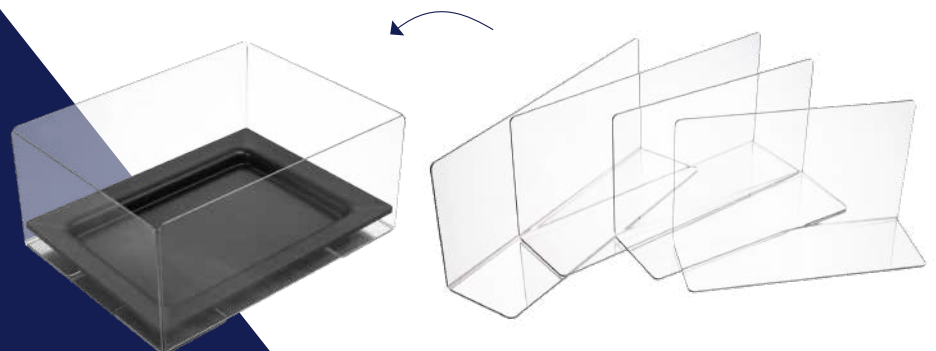

SY
8.0

Modular system 8.0

optimal for displays in counter depths between 800 – 840 mm

70 YEARS
Prico
Plex®

Professional
Food
Presentation

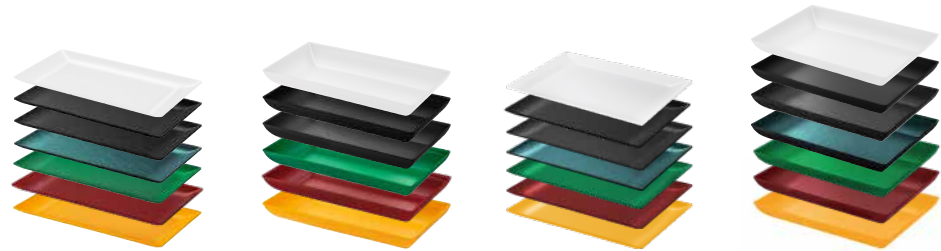

Dimensions in mm (LxWxH)	400 x 200 x 20	400 x 200 x 50	400 x 265 x 20	400 x 265 x 50
Volume	–	2.500 ml	–	3.700 ml
Item no.	GRC400200-20	GRC400200-50	GRC400265-20	GRC400265-50
white matt	0 -70 € 28,95	€ 28,95	€ 35,95	€ 35,95
black matt	1 -72 € 28,95	€ 28,95	€ 35,95	€ 35,95
graphite stone	2 -25 € 28,95	€ 28,95	€ 35,95	€ 35,95
petrol stone	3 -28 € 28,95	–	€ 35,95	€ 35,95
green matt	4 -74 € 28,95	€ 28,95	€ 35,95	€ 35,95
red matt	5 -75 € 28,95	€ 28,95	€ 35,95	€ 35,95
yellow matt	6 -76 € 28,95	€ 28,95	€ 35,95	€ 35,95

Compatible Accessories:

Honeycomb-Bottom Insert	GRCW400200-20	GRCW400200-50	GRCW400265-20	GRCW400265-50
white matt	0 -10 € 19,95	€ 19,95	€ 20,95	€ 20,95
black matt	1 -72 € 19,95	€ 19,95	€ 20,95	€ 20,95
green matt	2 -74 € 19,95	€ 19,95	€ 20,95	€ 20,95
red matt	3 -75 € 19,95	€ 19,95	€ 20,95	€ 20,95

Please add the color coding to the article number when ordering!

Prices plus VAT.

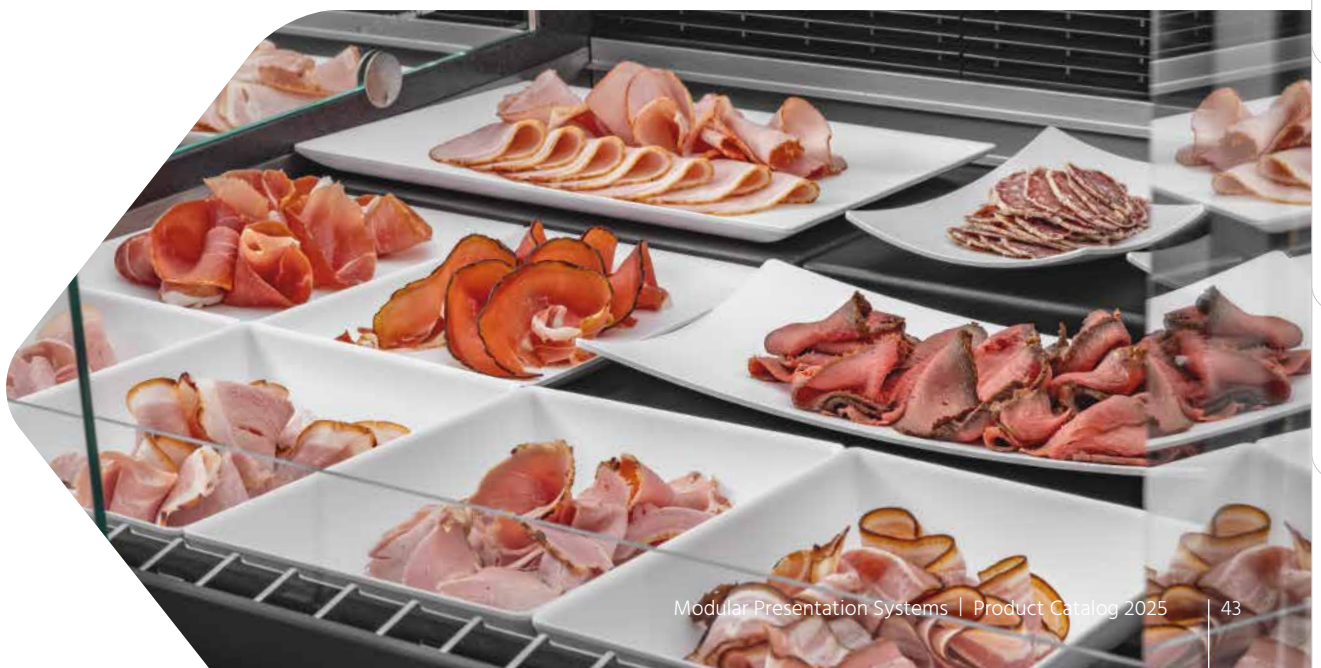



reddot winner 2025



Trays and Deep Trays Series GRACE

with Compatible Accessories

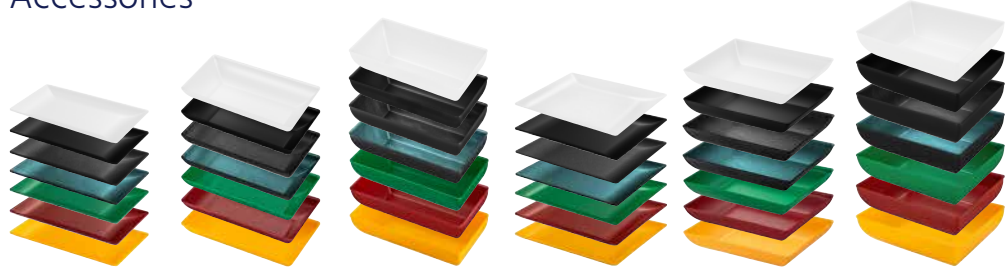

Dimensions in mm (LxWxH)	280 x 140 x 20	280 x 140 x 50	280 x 140 x 80	280 x 210 x 20	280 x 210 x 50	280 x 210 x 80
Volume	-	1.000 ml	2.000 ml	-	1.300 ml	3.000 ml
Item no.	GRC280140-20	GRC280140-50	GRC280140-80	GRC280210-20	GRC280210-50	GRC280210-80
white matt	0 -70 € 18,95	€ 18,95	€ 18,95	€ 22,95	€ 22,95	€ 22,95
black matt	1 -72 € 18,95	€ 18,95	€ 18,95	€ 22,95	€ 22,95	€ 22,95
graphit stone	2 -25 € 18,95	€ 18,95	€ 18,95	€ 22,95	€ 22,95	€ 22,95
petrol stone	3 -28 € 18,95	€ 18,95	€ 18,95	€ 22,95	€ 22,95	€ 22,95
green matt	4 -74 € 18,95	€ 18,95	€ 18,95	€ 22,95	€ 22,95	€ 22,95
red matt	5 -75 € 18,95	€ 18,95	€ 18,95	€ 22,95	€ 22,95	€ 22,95
yellow matt	6 -76 € 18,95	€ 18,95	€ 18,95	€ 22,95	€ 22,95	€ 22,95

Compatible Accessories:

Honeycomb-Bottom Insert	GRCW280140-20	GRCW280140-50	-	GRCW280210-20	GRCW280210-50	GRCW280210-80
white matt	0 -10 € 15,95	€ 15,95	-	€ 16,95	€ 16,95	€ 16,95
black matt	1 -72 € 15,95	€ 15,95	-	€ 16,95	€ 16,95	€ 16,95
green matt	2 -74 € 15,95	€ 15,95	-	€ 16,95	€ 16,95	€ 16,95
red matt	3 -75 € 15,95	€ 15,95	-	€ 16,95	€ 16,95	€ 16,95

Please add the color coding to the article number when ordering!

Prices plus VAT.



EXPERT TIP



Christian Priebe
Managing Director
PricoPlex

By using color contrasts and different shapes and surfaces for your Trays and Deep Trays, you create targeted, visually distinct and quickly recognizable separations between individual product groups, varieties and different origins, e. g. vegan, organic, poultry, fish ...

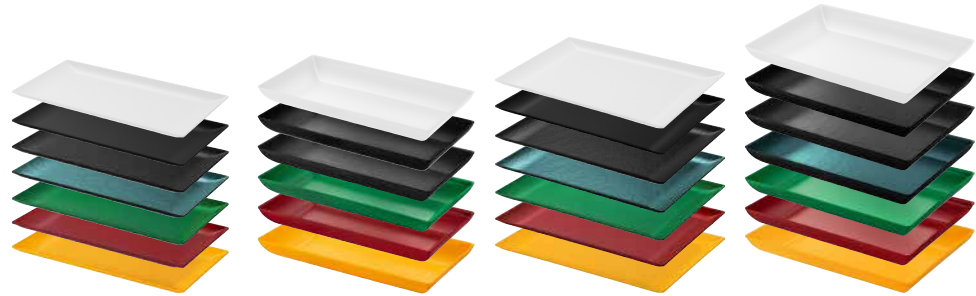

Dimensions in mm (LxWxH)	420 x 210 x 20	420 x 210 x 50	420 x 280 x 20	420 x 280 x 50
Volume	–	3.000 ml	–	3.600 ml
Item no.	GRC420210-20	GRC420210-50	GRC420280-20	GRC420280-50
white matt	0 -70 € 28,95	€ 28,95	€ 35,95	€ 35,95
black matt	1 -72 € 28,95	€ 28,95	€ 35,95	€ 35,95
graphit stone	2 -25 € 28,95	€ 28,95	€ 35,95	€ 35,95
petrol stone	3 -28 € 28,95	€ 28,95	€ 35,95	€ 35,95
green matt	4 -74 € 28,95	€ 28,95	€ 35,95	€ 35,95
red matt	5 -75 € 28,95	€ 28,95	€ 35,95	€ 35,95
yellow matt	6 -76 € 28,95	€ 28,95	€ 35,95	€ 35,95

Compatible Accessories:

Honeycomb-Bottom Insert	GRCW420210-20	GRCW420210-50	GRCW420280-20	GRCW420280-50
white matt	0 -10 € 19,95	€ 19,95	€ 20,95	€ 20,95
black matt	1 -72 € 19,95	€ 19,95	€ 20,95	€ 20,95
green matt	2 -74 € 19,95	€ 19,95	€ 20,95	€ 20,95
red matt	3 -75 € 19,95	€ 19,95	€ 20,95	€ 20,95

Please add the color coding to the article number when ordering!

Prices plus VAT.

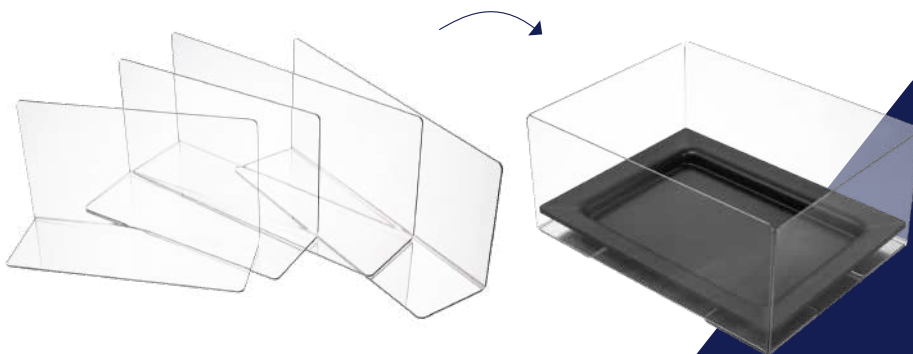

HYGIENE TIP

Fulfill hygiene regulations in a simple, practical way with our Panel Divider System. Available for Display Tray and Deep Tray 280 x 210 mm and 420 x 280 mm.

For details, see Page 135.



reddot winner 2025



Trays and Deep Trays Series GRACE

with Compatible Accessories



Dimensions in mm (LxWxH)	265 x 160 x 20	265 x 160 x 50	265 x 160 x 80	265 x 200 x 20	265 x 200 x 50
GN	1/4	1/4	1/4	1/5	1/5
Volume	-	1.200 ml	2.200 ml	-	1.700 ml
Item no.	GRC265160-20	GRC265160-50	GRC265160-80	GRC265200-20	GRC265200-50
white matt	-70 € 18,95	€ 18,95	€ 18,95	€ 22,95	€ 22,95
black matt	-72 € 18,95	€ 18,95	€ 18,95	€ 22,95	€ 22,95
graphite stone	-25 € 18,95	€ 18,95	€ 18,95	€ 22,95	€ 22,95
petrol stone	-28 -	-	-	-	-
green matt	-74 € 18,95	€ 18,95	€ 18,95	€ 22,95	€ 22,95
red matt	-75 € 18,95	€ 18,95	€ 18,95	€ 22,95	€ 22,95
yellow matt	-76 € 18,95	€ 18,95	€ 18,95	€ 22,95	€ 22,95

Compatible Accessories:

Honeycomb-Bottom Insert	GRCW265160-20	GRCW265160-50	-	GRCW265200-20	GRCW265200-50
white matt	-10 € 15,95	€ 15,95	-	€ 16,95	€ 16,95
black matt	-72 € 15,95	€ 15,95	-	€ 16,95	€ 16,95
green matt	-74 € 15,95	€ 15,95	-	€ 16,95	€ 16,95
red matt	-75 € 15,95	€ 15,95	-	€ 16,95	€ 16,95

Please add the color coding to the article number when ordering!

Prices plus VAT.





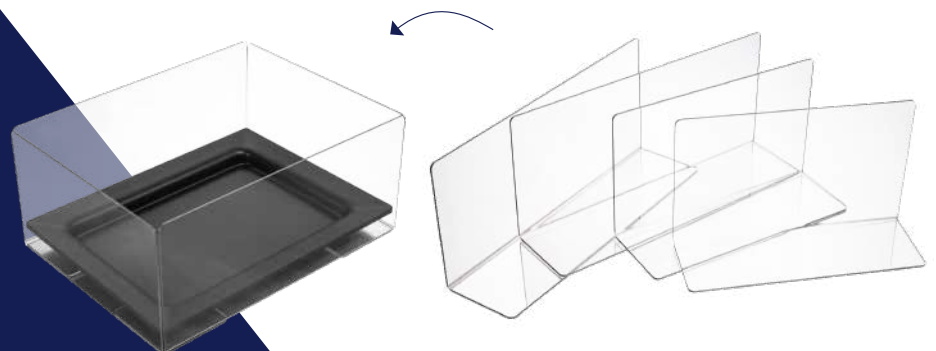

HYGIENE TIP

Fulfill hygiene regulations in a simple, practical way with our Panel Divider System. Available for Display Tray and Deep Tray 265 x 200 mm.

For details, see Page 135.





Dimensions in mm (LxWxH)		265 x 200 x 80	
GN		1/5	
Volume		2.700 ml	
Item no.		GRC265200-80	
weiß matt		-70	€ 22,95
schwarz matt		-72	€ 22,95
graphite stone		-25	€ 22,95
petrol stone		-28	-
green matt		-74	€ 22,95
red matt		-75	€ 22,95
yellow matt		-76	€ 22,95

Compatible Accessories:

Honeycomb-Bottom Insert		GRCW265200-80	
white matt		-10	€ 16,95
black matt		-72	€ 16,95
green matt		-74	€ 16,95
red matt		-75	€ 16,95

Prices plus VAT.

TIPS & NEWS

**Stay
up-to-date:**
Subscribe to
the Newsletter
now

You'll learn how simple it is to
make your day-to-day work easier
and generate more demand at
the same time.

Free of charge at:
www.pricoplex.com

THE CUSTOMER FAVORITE

Trays and Deep Trays Series FRESH

with Compatible Accessories



An evergreen product with a wide range of combinations: For years, the Series FRESH has been a real perennial favorite. Completely justified, because these Trays and bowls are available in a very wide range of system sizes.



YOUR ADVANTAGES

- ✓ More presentation possibilities through variety
- ✓ Reinforced edge
- ✓ Easy to combine
- ✓ Stackable to save space
- ✓ Can be placed as lid on display bowls
- ✓ Glossy colors: 



ACCESSORIES FOR SERIES FRESH

Patented Honeycomb-Bottom Insert

- ✓ Preserve the natural color of the meat
- ✓ Replace the use of paper as a base
- ✓ Prevents meat discoloration for up to 72 hours (for beef)
- ✓ Minimize weight loss of fresh meat due to storage weight loss
- ✓ Matt surfaces: 
- ✓ Glossy surfaces: 



Inlays / insert plates

- ✓ For beautiful visual accents
- ✓ Particularly natural look
- ✓ Can be customized using laser technology
- ✓ Slate and Wood look: 



Sieve inserts

- ✓ Insert for the bottom of the bowl
- ✓ For presentation of fish, offal, goulash, etc.
- ✓ Product does not lie in its own juice
- ✓ Color: Transparent 



Lid with Spoon Recess

- ✓ Prevents dehydration of the goods
- ✓ Spoon can remain in the container
- ✓ Color: Transparent 



Trays and Deep Trays

Series FRESH

with Compatible Accessories

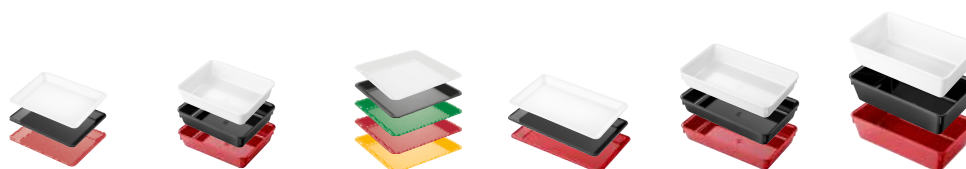

Dimensions in mm (LxWxH)	200 x 160 x 20	200 x 160 x 50	200 x 200 x 20	265 x 160 x 20	265 x 160 x 50	265 x 160 x 80
Volume	-	1.000 ml	-	-	1.300 ml	2.100 ml
Item no.	SAO200160-20	PPB200160-50	SAO200200-20	SAO265160-20	PPB265160-50	SAB265160-80
white glossy	0 -10 € 14,45	€ 14,95	€ 16,95	€ 15,95	€ 15,95	€ 16,95
black glossy	1 -02 € 14,45	€ 14,95	€ 16,95	€ 15,95	€ 15,95	€ 16,95
green glossy	2 -04 -	-	€ 16,95	-	-	-
red glossy	3 -05 € 14,45	€ 14,95	€ 16,95	€ 15,95	€ 15,95	€ 16,95
yellow glossy	4 -06 -	-	€ 16,95	-	-	-

Compatible Accessories:

Honeycomb-Bottom Insert	WBE200160-20	WBE200160-50	WBE200200-20	WBE265160-20	WBE265160-50	-
white matt	5 -70 € 14,95	€ 14,95	€ 14,95	€ 14,95	€ 14,95	-
black matt	6 -72 € 14,95	€ 14,95	€ 14,95	€ 14,95	€ 14,95	-
green matt	7 -74 € 14,95	€ 14,95	€ 14,95	€ 14,95	€ 14,95	-
red matt	8 -75 € 14,95	€ 14,95	€ 14,95	€ 14,95	€ 14,95	-
Inlay/insert plate	-	-	-	-	-	-
Slate look	9 -82 -	-	-	-	-	-
Wood look	10 -85 -	-	-	-	-	-
Lid with Spoon Recess	-	ZDL200160-50-00	-	-	ZDL265160-50-00	ZDL265160-80-00
transparent	-	€ 15,95	-	-	€ 17,95	€ 17,95
Perforated Basket Insert	SIE200160-50-00	-	-	SIE265160-50-00	SIE265160-80-00	SIE265160-80-00
transparent	€ 15,95	-	-	€ 15,95	€ 15,95	€ 15,95
Spit holder	-	-	-	-	-	-
black	-	-	-	-	-	-

Please add the color coding to the article number when ordering!

Prices plus VAT.

Fulfill hygiene regulations in a simple, practical way with our Panel Divider System. Available for Display Tray and Deep Tray 265 x 200 mm and 400 x 265 mm.

For details, see Page 135.

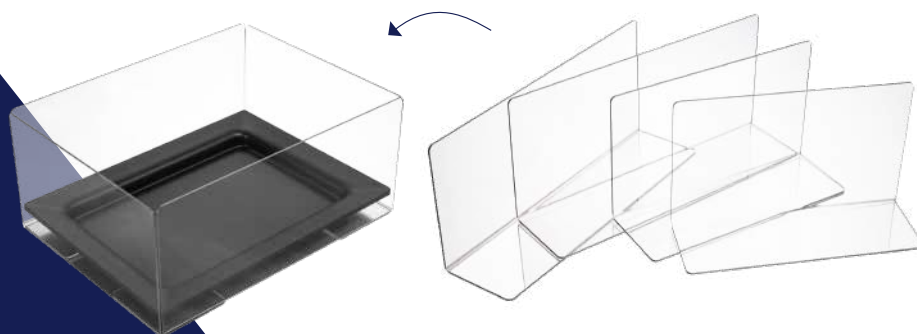

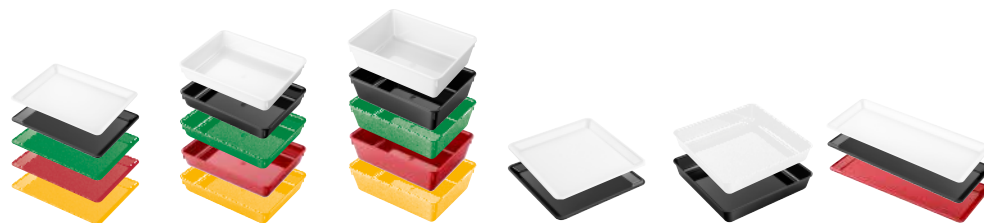

Dimensions in mm (L x W x H)	265 x 200 x 20	265 x 200 x 50	265 x 200 x 80	265 x 265 x 20	265 x 265 x 50	400 x 160 x 20
Volume	–	1.900 ml	2.900 ml	–	2.600 ml	–
Item no.	SAO265200-20	PPB265200-50	PPB265200-80	SAO265265-20	SAB265265-50	SAO400160-20
white glossy	0 -10 € 18,45	€ 18,45	€ 19,45	€ 19,95	€ 19,95	€ 19,45
black glossy	1 -02 € 18,45	€ 18,45	€ 19,45	€ 19,95	€ 19,95	€ 19,45
green glossy	2 -04 € 18,45	€ 18,45	€ 19,45	–	–	–
red glossy	3 -05 € 18,45	€ 18,45	€ 19,45	–	–	€ 19,45
yellow glossy	4 -06 € 18,45	€ 18,45	€ 19,45	–	–	–

Compatible Accessories:

Honeycomb-Bottom Insert	WBE265200-20	WBE265200-50	WBE265200-80	WBE265265-20	WBE265265-50	WBE400160-20
white matt	5 -70 € 14,95	€ 14,95	€ 14,95	€ 15,95	€ 15,95	€ 15,95
black matt	6 -72 € 14,95	€ 14,95	€ 14,95	€ 15,95	€ 15,95	€ 15,95
green matt	7 -74 € 14,95	€ 14,95	€ 14,95	–	–	€ 15,95
red matt	8 -75 € 14,95	€ 14,95	€ 14,95	–	–	€ 15,95
Inlay/insert plate	INL265200-20	INL265200-50	INL265200-80	INL265265-20	INL265265-50	INL400160-20
Slate look	9 -82 € 17,95	€ 17,95	€ 17,95	€ 18,95	€ 18,95	€ 18,95
Wood look	10 -85 € 17,95	€ 17,95	€ 17,95	€ 18,95	€ 18,95	€ 18,95
Lid with Spoon Recess	–	ZDL265200-50-00	ZDL265200-80-00	–	–	–
transparent	–	€ 21,95	€ 21,95	–	–	–
Perforated Basket Insert	–	SIE265200-50-00	–	–	–	–
transparent	–	€ 19,95	–	–	–	–
Spit holder	SPH265200-02	SPH265200-02	–	–	–	–
black	€ 20,95	€ 20,95	–	–	–	–

Please add the color coding to the article number when ordering!

Prices plus VAT.

Spit holder

- ✓ Precisely and neatly presented
- ✓ Perfect for preparation
- ✓ Suitable for all common skewers
- ✓ Firm stand due to conical bore
- ✓ Handle for practical removal

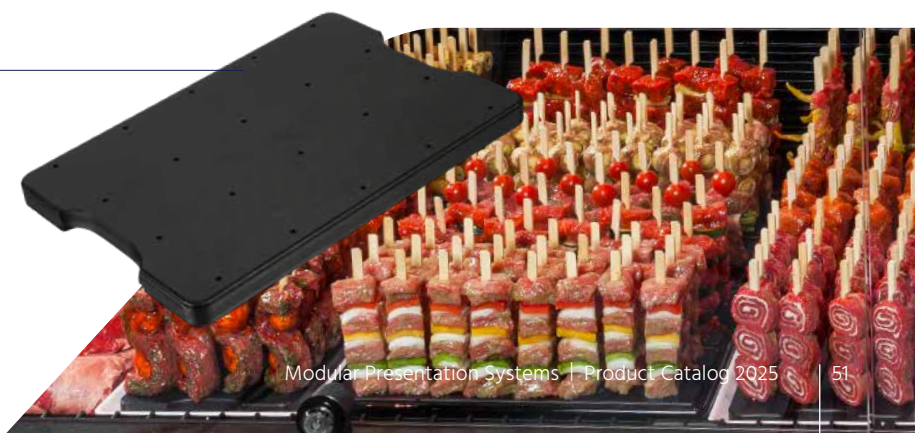

Trays and Deep Trays

Series FRESH

with Compatible Accessories



Dimensions in mm (LxWxH)	400 x 160 x 50	400 x 265 x 20	400 x 265 x 50	400 x 265 x 80	530 x 160 x 20
Volume	2.200 ml	–	4.000 ml	6.300 ml	–
Item no.	PPB400160-50	SAO400265-20	PPB400265-50	PPB400265-80	SAO530160-20
white glossy	0 -10 € 19,95	€ 22,95	€ 30,95	€ 33,95	€ 22,95
black glossy	1 -02 € 19,95	€ 22,95	€ 30,95	€ 33,95	€ 22,95
green glossy	2 -04 –	€ 22,95	–	–	–
red glossy	3 -05 € 19,95	€ 22,95	€ 30,95	€ 33,95	–
yellow glossy	4 -06 –	€ 22,95	–	–	–

Compatible Accessories:

Honeycomb-Bottom Insert	WBE400160-50	WBE400265-20	WBE400265-50	WBE400265-80	WBE530160-20
white matt	5 -70 € 15,95	€ 20,95	€ 20,95	€ 20,95	€ 20,95
black matt	6 -72 € 15,95	€ 20,95	€ 20,95	€ 20,95	€ 20,95
green matt	7 -74 € 15,95	€ 20,95	€ 20,95	€ 20,95	€ 20,95
red matt	8 -75 € 15,95	€ 20,95	€ 20,95	€ 20,95	€ 20,95
Inlay/insert plate	INL400160-50	INL400265-20	INL400265-50	–	INL530160-20
Slate look	9 -82 € 18,95	€ 22,95	€ 22,95	–	€ 22,95
Wood look	10 -85 € 18,95	€ 22,95	€ 22,95	–	€ 22,95
Lid with Spoon Recess	–	–	ZDL400265-50-00	ZDL400265-80-00	–
transparent	–	–	€ 24,95	€ 24,95	–
Perforated Basket Insert	SIE400160-50-00	–	SIE400265-50-00	–	–
transparent	€ 21,95	–	€ 26,95	–	–
Spit holder	–	–	–	–	–
black	–	–	–	–	–

Please add the color coding to the article number when ordering!

Prices plus VAT.



SY
8.0

Modular system 8.0

optimal for displays in counter depths between 800 – 840 mm

70 YEARS
Prico
Plex®

Professional
Food
Presentation



Dimensions in mm (L x W x H)	530 x 160 x 50	530 x 200 x 20	530 x 200 x 50
Volume	3.000 ml	-	3.700 ml
Item no.	SAB530160-50	SAO530200-20	SAB530200-50
white glossy	0 -10 € 22,95	€ 26,95	€ 28,95
black glossy	1 -02 € 22,95	€ 26,95	€ 28,95
green glossy	2 -04 -	-	-
red glossy	3 -05 -	-	-
yellow glossy	4 -06 -	-	-

Compatible Accessories:

Honeycomb-Bottom Insert	WBE530160-50	WBE530200-20	WBE530200-50
white matt	5 -70 € 20,95	€ 22,95	€ 22,95
black matt	6 -72 € 20,95	€ 22,95	€ 22,95
green matt	7 -74 € 20,95	€ 22,95	€ 22,95
red matt	8 -75 € 20,95	€ 22,95	€ 22,95
Inlay/insert plate	INL530160-50	-	-
Slate look	9 -82 € 22,95	-	-
Wood look	10 -85 € 22,95	-	-
Lid with Spoon Recess	ZDL530160-50-00	-	-
transparent	€ 24,95	-	-
Perforated Basket Insert	-	-	-
transparent	-	-	-
Spit holder	-	-	-
black	-	-	-

Please add the color coding to the article number when ordering!

Prices plus VAT.

Trays and Deep Trays Series FRESH

with Compatible Accessories

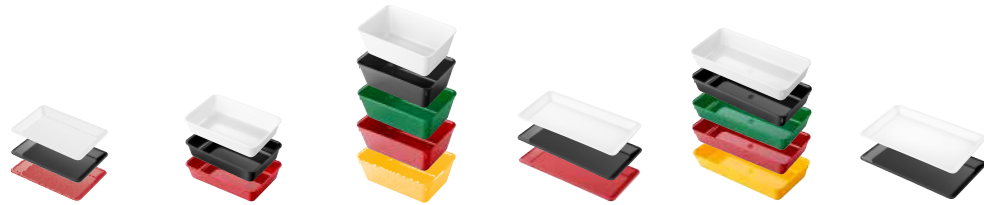

Dimensions in mm (LxWxH)	210 x 140 x 20	210 x 140 x 50	210 x 140 x 80	280 x 140 x 20	280 x 140 x 50	280 x 168 x 20
Volume	–	950 ml	1.500 ml	–	1.300 ml	–
Item no.	SAO210140-20	SAB210140-50	PPB210140-80	SAO280140-20	PPB280140-50	SAO280168-20
white glossy	0 -10 € 14,45	€ 14,45	€ 15,95	€ 16,95	€ 16,95	€ 18,95
black glossy	1 -02 € 14,45	€ 14,45	€ 15,95	€ 16,95	€ 16,95	€ 18,95
green glossy	2 -04 –	–	€ 15,95	–	€ 16,95	–
red glossy	3 -05 € 14,45	€ 14,45	€ 15,95	€ 16,95	€ 16,95	–
yellow glossy	4 -06 –	–	€ 15,95	–	€ 16,95	–

Compatible Accessories:

Honeycomb-Bottom Insert	WBE210140-20	WBE210140-50	–	WBE280140-20	WBE280140-50	WBE280168-20
white matt	5 -70 € 13,95	€ 13,95	–	€ 14,95	€ 14,95	€ 15,95
black matt	6 -72 € 13,95	€ 13,95	–	€ 14,95	€ 14,95	€ 15,95
green matt	7 -74 € 13,95	€ 13,95	–	€ 14,95	€ 14,95	€ 15,95
red matt	8 -75 € 13,95	€ 13,95	–	€ 14,95	€ 14,95	€ 15,95
Inlay/insert plate	INL210140-20	–	–	INL280140-20	–	–
Slate look	9 -82 € 13,95	–	–	€ 14,95	–	–
Wood look	10 -85 € 13,95	–	–	€ 14,95	–	–
Lid with Spoon Recess	–	ZDL210140-50-00	ZDL210140-80-00	–	ZDL280140-50-00	–
transparent	–	€ 14,45	€ 14,45	–	€ 15,95	–
Perforated Basket Insert	–	SIE210140-50-00	SIE210140-80-00	–	SIE280140-50-00	–
transparent	–	€ 14,45	€ 14,45	–	€ 15,95	–
Spit holder	–	–	–	–	–	–
black	–	–	–	–	–	–

Please add the color coding to the article number when ordering!

Prices plus VAT.

Fulfill hygiene regulations in a simple, practical way with our Panel Divider System. Available for Display Tray and deep Tray 280 x 210 mm and 420 x 280 mm.

For details, see Page 135.

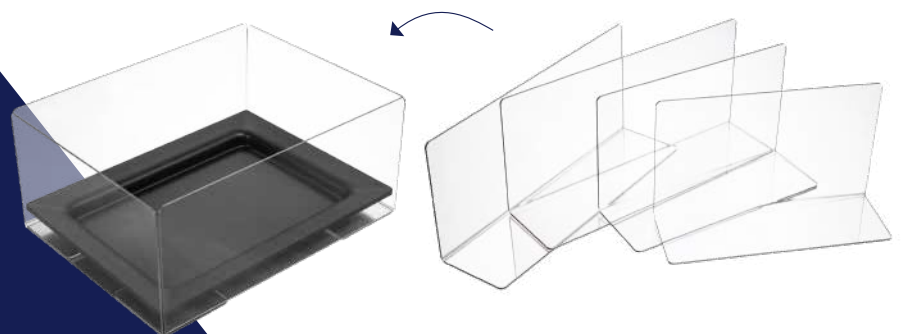

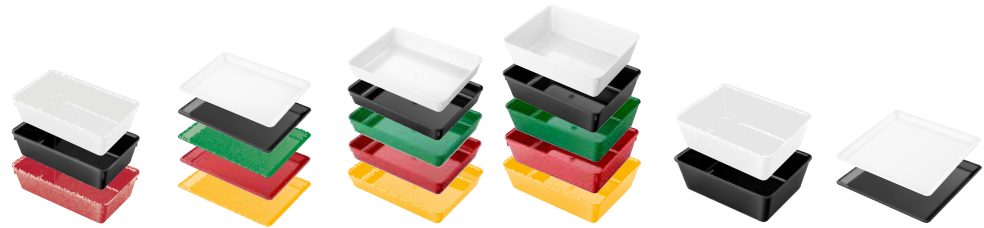

Dimensions in mm (L x W x H)	280 x 168 x 80	280 x 210 x 20	280 x 210 x 50	280 x 210 x 80	280 x 210 x 100	280 x 280 x 20
Volume	2.500 ml	-	2.000 ml	3.200 ml	3.800 ml	-
Item no.	PPB280168-80	SAO280210-20	PPB280210-50	PPB280210-80	SAB280210-100	SAO280280-20
white glossy	0 -10 € 18,95	€ 18,95	€ 18,95	€ 19,95	€ 26,95	€ 20,95
black glossy	1 -02 € 18,95	€ 18,95	€ 18,95	€ 19,95	€ 26,95	€ 20,95
green glossy	2 -04 -	€ 18,95	€ 18,95	€ 19,95	-	-
red glossy	3 -05 € 18,95	€ 18,95	€ 18,95	€ 19,95	-	-
yellow glossy	4 -06 -	€ 18,95	€ 18,95	€ 19,95	-	-

Compatible Accessories:

Honeycomb-Bottom Insert	-	WBE280210-20	WBE280210-50	-	-	WBE280280-20
white matt	5 -70 -	€ 16,95	€ 16,95	-	-	€ 17,95
black matt	6 -72 -	€ 16,95	€ 16,95	-	-	€ 17,95
green matt	7 -74 -	€ 16,95	€ 16,95	-	-	€ 17,95
red matt	8 -75 -	€ 16,95	€ 16,95	-	-	€ 17,95
Inlay/insert plate	-	-	-	-	-	-
Slate look	9 -82 -	-	-	-	-	-
Wood look	10 -85 -	-	-	-	-	-
Lid with Spoon Recess	ZDL280168-80-00	-	ZDL280210-50-00	ZDL280210-80-00	ZDL280210-100-00	-
transparent	€ 17,95	-	€ 17,95	€ 17,95	€ 17,95	-
Perforated Basket Insert	SIE280168-80-00	-	SIE280210-50-00	SIE280210-80-00	SIE280210-100-00	-
transparent	€ 17,95	-	€ 17,95	€ 17,95	€ 17,95	-
Spit holder	-	SPH280210-02	SPH280210-02	-	-	-
black	-	€ 20,95	€ 20,95	-	-	-

Please add the color coding to the article number when ordering!

Prices plus VAT.

Trays and Deep Trays

Series FRESH

with Compatible Accessories

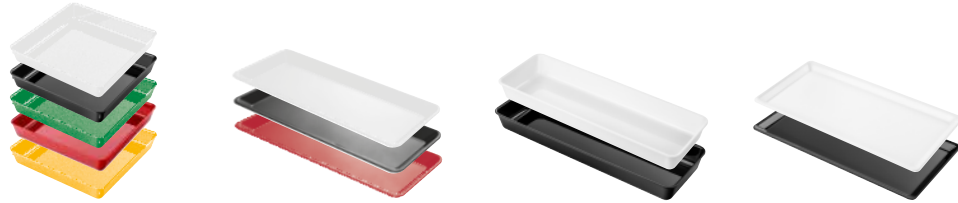

Dimensions in mm (LxWxH)	280 x 280 x 50	420 x 140 x 20	420 x 140 x 50	420 x 210 x 20
Volume	2.500 ml	–	2.000 ml	–
Item no.	PPB280280-50	SAO420140-20	SAB420140-50	SAO420210-20
white glossy	0 -10 € 20,95	€ 19,95	€ 19,95	€ 21,95
black glossy	1 -02 € 20,95	€ 19,95	€ 19,95	€ 21,95
green glossy	2 -04 € 20,95	–	–	–
red glossy	3 -05 € 20,95	€ 19,95	–	–
yellow glossy	4 -06 € 20,95	–	–	–

Compatible Accessories:

Honeycomb-Bottom Insert	WBE280280-50	WBE420140-20	WBE420140-50	WBE420210-20
white matt	0 -70 € 17,95	€ 18,95	€ 18,95	€ 19,95
black matt	1 -72 € 17,95	€ 18,95	€ 18,95	€ 19,95
green matt	2 -74 –	–	–	–
red matt	3 -75 –	–	–	–
Inlay/insert plate	–	–	–	INL420210-20
Slate look	4 -82 –	–	–	€ 19,95
Wood look	5 -85 –	–	–	€ 19,95
Lid with Spoon Recess	ZDL280280-50-00	–	ZDL420140-50-00	–
transparent	€ 19,95	–	€ 18,95	–
Perforated Basket Insert	–	–	SIE420140-50-00	–
transparent	–	–	€ 18,95	–
Spit holder	–	–	–	–
black	–	–	–	–

Please add the color coding to the article number when ordering!

Prices plus VAT.

Fulfill hygiene regulations in a simple, practical way with our Panel Divider System. Available for Display Tray and Deep Tray 280 x 210 mm und 420 x 280 mm.

For details, see Page 135.

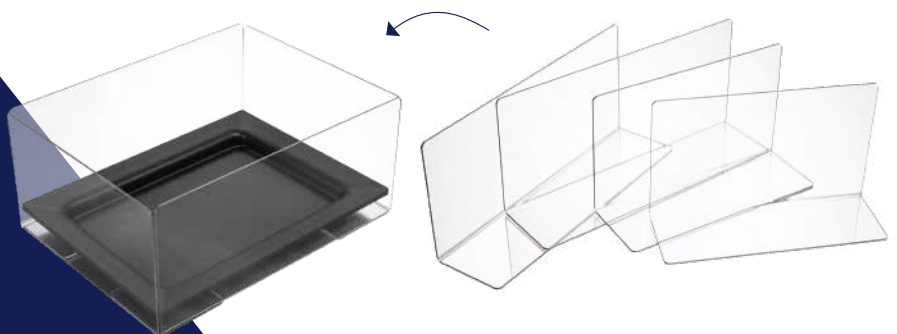

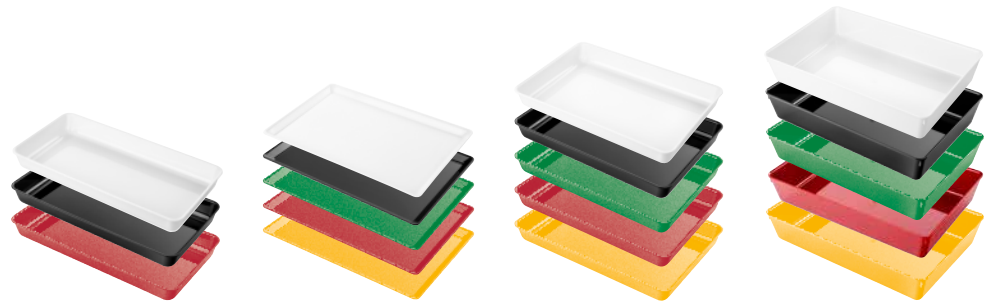

Dimensions in mm (L x W x H)	420 x 210 x 50	420 x 280 x 20	420 x 280 x 50	420 x 280 x 80
Volume	3.000 ml	–	4.100 ml	7.000 ml
Item no.	SAB420210-50	SAO420280-20	SAB420280-50	PPB420280-80
white glossy	0 -10 € 21,95	€ 24,95	€ 30,95	€ 33,95
black glossy	1 -02 € 21,95	€ 24,95	€ 30,95	€ 33,95
green glossy	2 -04 –	€ 24,95	€ 30,95	€ 33,95
red glossy	3 -05 € 21,95	€ 24,95	€ 30,95	€ 33,95
yellow glossy	4 -06 –	€ 24,95	€ 30,95	€ 33,95

Compatible Accessories:

Honeycomb-Bottom Insert	WBE420210-50	WBE420280-20	WBE420280-50	–
white matt	0 -70 € 19,95	€ 21,95	€ 21,95	–
black matt	1 -72 € 19,95	€ 21,95	€ 21,95	–
green matt	2 -74 € 19,95	€ 21,95	€ 21,95	–
red matt	3 -75 € 19,95	€ 21,95	€ 21,95	–
Inlay/insert plate	INL420210-50	INL420280-20	INL420280-50	–
Slate look	0 -82 € 19,95	€ 21,95	€ 21,95	–
Wood look	1 -85 € 19,95	€ 21,95	€ 21,95	–
Lid with Spoon Recess	–	–	ZDL420280-50-00	ZDL420280-80-00
transparent	–	–	€ 26,95	€ 26,95
Perforated Basket Insert	SIE420210-50-00	–	SIE420280-50-00	–
transparent	€ 19,95	–	€ 27,45	–
Spit holder	–	–	–	–
black	–	–	–	–

Please add the color coding to the article number when ordering!

Prices plus VAT.

Looking for design ideas?

Use our individual planning service for your counter in a flexible modular system.

Book online appointment at:



**Simply scan via
smartphone and
select appointment!**

Trays and Deep Trays Series FRESH

with Compatible Accessories



Dimensions in mm (LxWxH)	560 x 210 x 20	560 x 280 x 20	560 x 280 x 50
Volume	-	-	6.000 ml
Item no.	SAO560210-20	SAO560280-20	SAB560280-50
white glossy	0 -10 € 27,95	€ 36,95	€ 36,95
black glossy	1 -02 € 27,95	€ 36,95	€ 36,95
green glossy	2 -04 -	-	-
red glossy	3 -05 -	-	-
yellow glossy	4 -06 -	-	-

Compatible Accessories:

Honeycomb-Bottom Insert	-	-	-
white matt	5 -70 -	-	-
black matt	6 -72 -	-	-
green matt	7 -74 -	-	-
red matt	8 -75 -	-	-
Inlay/insert plate	-	-	-
Slate look	9 -82 -	-	-
Wood look	10 -85 -	-	-
Lid with Spoon Recess	-	-	-
transparent	-	-	-
Perforated Basket Insert	-	-	-
transparent	-	-	-
Spit holder	-	-	-
black	-	-	-

Please add the color coding to the article number when ordering!

Prices plus VAT.

EXPERT TIP



Klaus Wydra
PricoPlex
Customer Consultant

“We are seeing an increasing variety in the fresh food counters. For optimal presentation, we recommend different shapes, sizes and surfaces of the containers, which complement each other perfectly.”

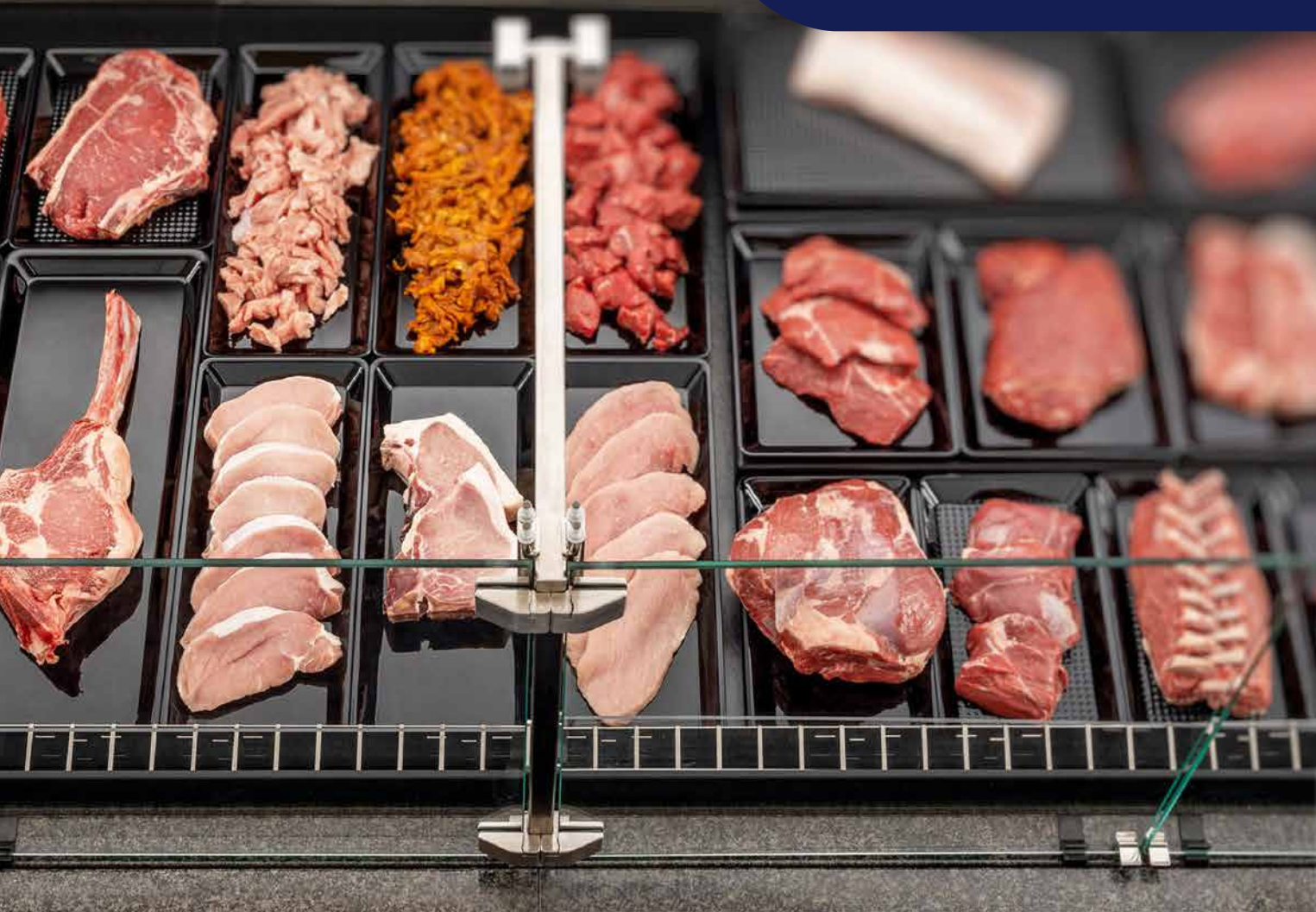

Trays and Deep Trays Series FRESH

with Compatible Accessories



Dimensions in mm (L x W x H)	220 x 145 x 20	220 x 145 x 50	220 x 145 x 80	290 x 145 x 20	290 x 145 x 50
Volume	–	1.000 ml	1.700 ml	–	1.400 ml
Item no.	SAO220145-20	SAB220145-50	SAB220145-80	SAO290145-20	PPB290145-50
white glossy	0 -10 € 14,95	€ 16,95	€ 18,45	€ 17,95	€ 19,45
black glossy	1 -02 € 14,95	€ 16,95	€ 18,45	€ 17,95	€ 19,45
green glossy	2 -04 –	–	–	–	–
red glossy	3 -05 € 14,95	€ 16,95	€ 18,45	€ 17,95	€ 19,45
yellow glossy	4 -06 –	–	–	–	–

Compatible Accessories:

Honeycomb-Bottom Insert	–	–	–	WBE290145-20	WBE290145-50
white matt	5 -70 –	–	–	€ 15,95	€ 15,95
black matt	6 -72 –	–	–	€ 15,95	€ 15,95
green matt	7 -74 –	–	–	–	–
red matt	8 -75 –	–	–	–	–
Lid with Spoon Recess	–	–	–	–	–
transparent	–	–	–	–	–
Perforated Basket Insert	–	–	–	–	–
transparent	–	–	–	–	–

Please add the color coding to the article number when ordering!

Prices plus VAT.

TIPS & TRICKS

The light meat of chicken and turkey can be ideally presented on red Display Trays. Their glossy surface emphasizes the freshness of the meat.





Dimensions in mm (L x W x H)	290 x 145 x 80	290 x 220 x 20	290 x 220 x 50	290 x 220 x 80	290 x 290 x 20
Volume	2.200 ml	-	2.300 ml	3.400 ml	-
Item no.	PPB290145-80	SAO290220-20	SAB290220-50	SAB290220-80	SAO290290-20
white glossy	0 -10 € 19,45	€ 19,45	€ 19,45	€ 21,45	€ 21,95
black glossy	0 -02 € 19,45	€ 19,45	€ 19,45	€ 21,45	€ 21,95
green glossy	0 -04 -	-	-	-	-
red glossy	0 -05 € 19,45	€ 19,45	€ 19,45	€ 21,45	-
yellow glossy	0 -06 -	-	-	-	-

Compatible Accessories:

Honeycomb-Bottom Insert	-	WBE290220-20	WBE290220-50	-	WBE290290-20
white matt	0 -70 -	€ 17,95	€ 17,95	-	€ 18,45
black matt	0 -72 -	€ 17,95	€ 17,95	-	€ 18,45
green matt	0 -74 -	€ 17,95	€ 17,95	-	€ 18,45
red matt	0 -75 -	€ 17,95	€ 17,95	-	€ 18,45
Lid with Spoon Recess	-	-	ZDL290220-50-00	ZDL290220-80-00	-
transparent	-	-	€ 18,95	€ 18,95	-
Perforated Basket Insert	-	-	SIE290220-50-00	-	-
transparent	-	-	€ 18,95	-	-

Please add the color coding to the article number when ordering!

Prices plus VAT.

Trays and Deep Trays

Series FRESH

with Compatible Accessories



Dimensions in mm (LxWxH)	290 x 290 x 50	440 x 290 x 20	440 x 290 x 50	660 x 290 x 20
Volume	2.700 ml	-	4.500 ml	-
Item no.	SAB290290-50	SAO440290-20	SAB440290-50	SAO660290-20
white glossy	0 -10 € 22,95	€ 24,95	€ 31,95	€ 43,95
black glossy	1 -02 € 22,95	€ 24,95	€ 31,95	€ 43,95
green glossy	2 -04 -	-	-	-
red glossy	3 -05 -	€ 24,95	-	-
yellow glossy	4 -06 -	-	-	-

Compatible Accessories:

Honeycomb-Bottom Insert	WBE290290-50	WBE440290-20	WBE440290-50	-
white matt	5 -70 € 18,45	€ 21,45	€ 21,45	-
black matt	6 -72 € 18,45	€ 21,45	€ 21,45	-
green matt	7 -74 € 18,45	€ 21,45	€ 21,45	-
red matt	8 -75 € 18,45	€ 21,45	€ 21,45	-
Lid with Spoon Recess	-	-	-	-
transparent	-	-	-	-
Perforated Basket Insert	-	-	SIE440290-50-00	-
transparent	-	-	€ 26,95	-

Please add the color coding to the article number when ordering!

Prices plus VAT.



Trays and Deep Trays

Series FRESH

with Compatible Accessories



Dimensions in mm (L x W x H)	265 x 160 x 20	265 x 160 x 50	265 x 160 x 80	265 x 200 x 20	265 x 200 x 50
GN	1/4	1/4	1/4	1/5	1/5
Volume	–	1.300 ml	2.100 ml	–	1.900 ml
Item no.	SAO265160-20	PPB265160-50	SAB265160-80	SAO265200-20	PPB265200-50
white glossy	☐ -10 € 15,95	€ 15,95	€ 16,95	€ 18,45	€ 18,45
black glossy	◼ -02 € 15,95	€ 15,95	€ 16,95	€ 18,45	€ 18,45
green glossy	◼ -04 –	–	–	€ 18,45	€ 18,45
red glossy	◼ -05 € 15,95	€ 15,95	€ 16,95	€ 18,45	€ 18,45
yellow glossy	◼ -06 –	–	–	€ 18,45	€ 18,45

Compatible Accessories:

Honeycomb-Bottom Insert	WBE265160-20	WBE265160-50	–	WBE265200-20	WBE265200-50
white matt	☐ -70 € 14,95	€ 14,95	–	€ 14,95	€ 14,95
black matt	◼ -72 € 14,95	€ 14,95	–	€ 14,95	€ 14,95
green matt	◼ -74 € 14,95	€ 14,95	–	€ 14,95	€ 14,95
red matt	◼ -75 € 14,95	€ 14,95	–	€ 14,95	€ 14,95
Inlay/insert plate	–	–	–	INL265200-20	INL265200-50
Slate look	◼ -82 –	–	–	€ 17,95	€ 17,95
Wood look	◼ -85 –	–	–	€ 17,95	€ 17,95
Lid with Spoon Recess	–	ZDL265160-50-00	ZDL265160-80-00	–	ZDL265200-50-00
transparent	–	€ 17,95	€ 17,95	–	€ 21,95
Perforated Basket Insert	–	SIE265160-50-00	SIE265160-80-00	–	SIE265200-50-00
transparent	–	€ 15,95	€ 15,95	–	€ 19,95
Spit holder	–	–	–	SPH265200-02	SPH265200-02
black	–	–	–	€ 20,95	€ 20,95

Please add the color coding to the article number when ordering!



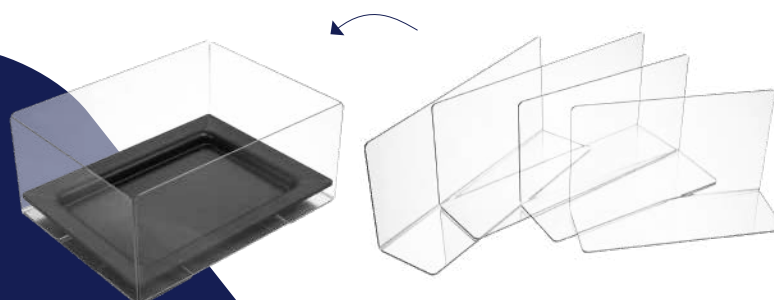

Prices plus VAT.

Fulfill hygiene regulations in a simple, practical way with our Panel Divider System. Available for Display Tray and Deep Tray 265 x 200 mm.







For details, see Page 135.





Dimensions in mm (LxWxH)	265 x 200 x 80	325 x 176 x 20	325 x 176 x 50	325 x 176 x 80	325 x 265 x 20	
GN	1/5	1/3	1/3	1/3	1/2	
Volume	2.900 ml	-	2.000 ml	3.300 ml	-	
Item no.	PPB265200-80	SAO325176-20	SAB325176-50	SAB325176-80	SAO325265-20	
white glossy	 -10	€ 19,45	€ 19,95	€ 19,95	€ 21,45	€ 21,95
black glossy	 -02	€ 19,45	€ 19,95	€ 19,95	€ 21,45	€ 21,95
green glossy	 -04	€ 19,45	-	-	-	-
red glossy	 -05	€ 19,45	-	-	-	-
yellow glossy	 -06	€ 19,45	-	-	-	-

Compatible Accessories:

Honeycomb-Bottom Insert	-	WBE325176-20	WBE325176-50	-	WBE325265-20
white matt	 -70	€ 17,95	€ 17,95	-	€ 18,95
black matt	 -72	€ 17,95	€ 17,95	-	€ 18,95
green matt	 -74	€ 17,95	€ 17,95	-	€ 18,95
red matt	 -75	€ 17,95	€ 17,95	-	€ 18,95
Inlay/insert plate	-	-	-	-	-
Slate look	 -82	-	-	-	-
Wood look	 -85	-	-	-	-
Lid with Spoon Recess	ZDL265200-80-00	-	ZDL325176-50-00	ZDL325176-80-00	-
transparent	€ 21,95	-	€ 21,95	€ 21,95	-
Perforated Basket Insert	-	-	-	-	-
transparent	-	-	-	-	-
Spit holder	-	-	-	-	-
black	-	-	-	-	-

Please add the color coding to the article number when ordering!

Prices plus VAT.

Trays and Deep Trays

Series FRESH

with Compatible Accessories



Dimensions in mm (LxWxH)	325 x 265 x 50	325 x 265 x 80	487 x 265 x 20	487 x 265 x 50	530 x 160 x 20	
GN	1/2	1/2	3/4	3/4	2/4	
Volume	3.000 ml	5.200 ml	-	4.500 ml	-	
Item no.	SAB325265-50	SAB325265-80	SAO487265-20	SAB487265-50	SAO530160-20	
white glossy	-10	€ 21,95	€ 24,45	€ 28,95	€ 32,95	€ 22,95
black glossy	-02	€ 21,95	€ 24,45	€ 28,95	€ 32,95	€ 22,95
green glossy	-04	-	-	-	-	-
red glossy	-05	-	-	-	-	-
yellow glossy	-06	-	-	-	-	-





Compatible Accessories:

Honeycomb-Bottom Insert	WBE325265-50	-	-	-	WBE530160-20
white matt	-70	€ 18,95	-	-	€ 20,95
black matt	-72	€ 18,95	-	-	€ 20,95
green matt	-74	€ 18,95	-	-	€ 20,95
red matt	-75	€ 18,95	-	-	€ 20,95
Inlay/insert plate	-	-	-	-	INL530160-20
Slate look	-82	-	-	-	€ 22,95
Wood look	-85	-	-	-	€ 22,95
Lid with Spoon Recess	-	-	-	-	-
transparent	-	-	-	-	-
Perforated Basket Insert	-	-	-	-	-
transparent	-	-	-	-	-
Spit holder	-	-	-	-	-
black	-	-	-	-	-







Please add the color coding to the article number when ordering!

Prices plus VAT.



Dimensions in mm (LxWxH)	530 x 160 x 50	530 x 200 x 20	530 x 200 x 50	530 x 325 x 20	530 x 325 x 50	
GN	2/4	2/5	2/5	1/1	1/1	
Volume	3.000 ml	-	3700 ml	-	6.000 ml	
Item no.	SAB530160-50	SAO530200-20	SAB530200-50	SAO530325-20	SAB530325-50	
white glossy	 -10	€ 22,95	€ 26,95	€ 28,95	€ 33,95	€ 37,95
black glossy	 -02	€ 22,95	€ 26,95	€ 28,95	€ 33,95	€ 37,95
green glossy	 -04	-	-	-	-	-
red glossy	 -05	-	-	-	-	-
yellow glossy	 -06	-	-	-	-	-

Compatible Accessories:

Honeycomb-Bottom Insert	WBE530160-50	WBE530200-20	WBE530200-50	-	-
white matt	 -70	€ 20,95	€ 22,95	€ 22,95	-
black matt	 -72	€ 20,95	€ 22,95	€ 22,95	-
green matt	 -74	-	-	-	-
red matt	 -75	-	-	-	-
Inlay/insert plate	-	-	-	-	-
Slate look	 -82	-	-	-	-
Wood look	 -85	-	-	-	-
Lid with Spoon Recess	ZDL530160-50-00	-	-	-	-
transparent	€ 24,95	-	-	-	-
Perforated Basket Insert	-	-	-	-	-
transparent	-	-	-	-	-
Spit holder	-	-	-	-	-
black	-	-	-	-	-

Please add the color coding to the article number when ordering!

Prices plus VAT.

Other sizes

popular sizes outside the standard systems

Trays and Deep Trays Series FRESH

with Compatible Accessories



Dimensions in mm (L x W x H)	300 x 200 x 20	310 x 170 x 20	580 x 210 x 20	350 x 260 x 50	580 x 420 x 50	
Volume	-	-	-	1.400 ml	3.000 ml	
Item no.	SAO300200-20	SAO310170-20	SAO580210-20	SAB350260-50	SAB580420-50	
white glossy	0 -10	€ 19,45	€ 19,45	€ 27,95	€ 21,45	€ 32,95
black glossy	1 -02	€ 19,45	€ 19,45	€ 27,95	€ 21,45	€ 32,95
green glossy	2 -04	-	-	-	-	-
red glossy	3 -05	-	-	-	€ 21,45	-
yellow glossy	4 -06	-	-	-	-	-
champagne gl.	5 -12	-	-	-	-	-

Compatible Accessories:

Honeycomb-Bottom Insert	-	-	-	-	-
white matt	6 -70	€ 15,95	€ 15,95	-	-
black matt	7 -72	€ 15,95	€ 15,95	-	-
green matt	8 -74	-	-	-	-
red matt	9 -75	-	-	-	-
Inlay/insert plate	-	-	-	-	-
Slate look	10 -82	€ 15,95	€ 15,95	-	-
Wood look	11 -85	€ 15,95	€ 15,95	-	-
Lid with Spoon Recess	-	-	-	-	-
transparent	-	-	-	-	-
Perforated Basket Insert	-	-	-	-	-
transparent	-	-	-	-	-
Spit holder	-	-	-	-	-
black	-	-	-	-	-

Please add the color coding to the article number when ordering!

Prices plus VAT.

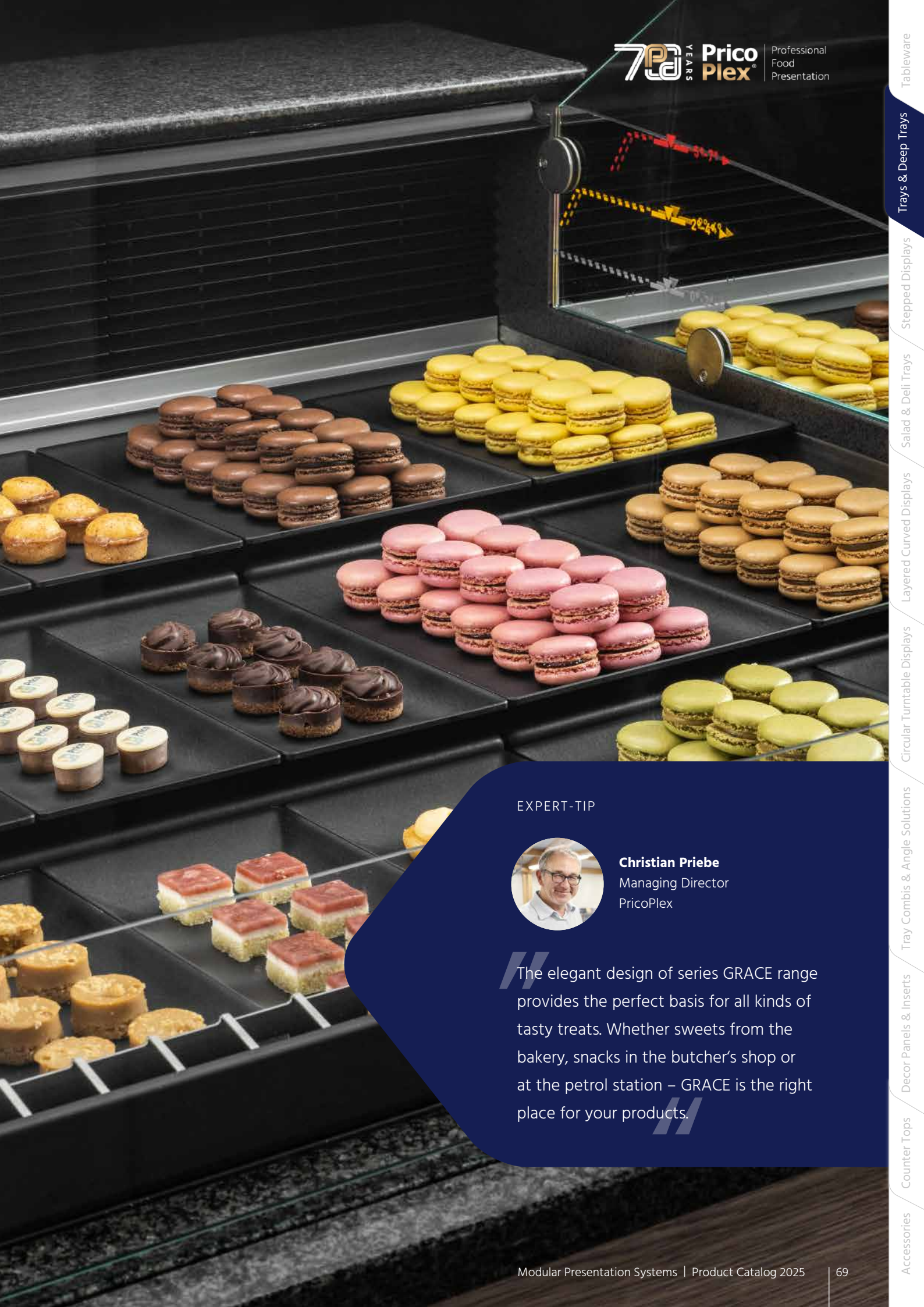

EXPERT-TIP



Christian Priebe
Managing Director
PricoPlex

“The elegant design of series GRACE range provides the perfect basis for all kinds of tasty treats. Whether sweets from the bakery, snacks in the butcher’s shop or at the petrol station – GRACE is the right place for your products.”

Other sizes

popular sizes outside the standard systems

Trays and Deep Trays Series FRESH

with Compatible Accessories



Dimensions in mm (L x W x H)	180 x 180 x 80	210 x 160 x 80	240 x 160 x 50	260 x 160 x 70	260 x 190 x 40
Volume	1.600 ml	1.900 ml	1.300 ml	2.000 ml	1.300 ml
Item no.	SAB180180-80	SAB210160-80	SAB240160-50	SAB260160-70	SAB260190-40
white glossy	€ 16,95	€ 16,95	€ 16,95	€ 18,95	€ 16,95
black glossy	€ 16,95	€ 16,95	€ 16,95	€ 18,95	€ 16,95
green glossy	€ 16,95	-	-	-	-
red glossy	-	€ 16,95	-	-	-
yellow glossy	-	-	-	-	-
champagne gl.	-	-	-	-	-

Compatible Accessories:

Honeycomb-Bottom Insert	-	-	-	-	-
white matt	-	-	-	-	-
black matt	-	-	-	-	-
green matt	-	-	-	-	-
red matt	-	-	-	-	-
Inlay/insert plate	-	-	-	-	-
Slate look	-	-	-	-	-
Wood look	-	-	-	-	-
Lid with Spoon Recess	ZDL180180-80-00	ZDL210160-80-00	ZDL240160-50-00	ZDL260160-70	ZDL260190-40-00
transparent	€ 14,95	€ 15,95	€ 16,95	€ 16,95	€ 16,95
Perforated Basket Insert	SIE180180-80-00	SIE210160-80-00	SIE240160-50-00	SIE260160-70	SIE260190-40-00
transparent	€ 14,95	€ 15,95	€ 16,95	€ 16,95	€ 16,95
Spit holder	-	-	-	-	-
black	-	-	-	-	-

Please add the color coding to the article number when ordering!

Prices plus VAT.

Other sizes

popular sizes outside the standard systems



Dimensions in mm (LxWxH)	280 x 190 x 50	290 x 160 x 50	310 x 240 x 50	310 x 240 x 80	310 x 240 x 100
Volume	1.900 ml	1.600 ml	2.800 ml	4.000 ml	5.500 ml
Item no.	SAB280190-50	SAB290160-50	SAB310240-50	SAB310240-80	SAB310240-100
white glossy	0 -10 € 17,95	€ 16,95	€ 21,95	€ 27,95	€ 32,95
black glossy	1 -02 € 17,95	€ 16,95	€ 21,95	€ 27,95	€ 32,95
green glossy	2 -04 -	-	-	-	-
red glossy	3 -05 -	-	-	-	-
yellow glossy	4 -06 -	-	-	-	-
champagne gl.	5 -12 -	-	-	-	-

Compatible Accessories:

Honeycomb-Bottom Insert	-	-	-	-	-
white matt	6 -70 -	-	-	-	-
black matt	7 -72 -	-	-	-	-
green matt	8 -74 -	-	-	-	-
red matt	9 -75 -	-	-	-	-
Inlay/insert plate	-	-	-	-	-
Slate look	10 -82 -	-	-	-	-
Wood look	11 -85 -	-	-	-	-
Lid with Spoon Recess	ZDL280190-50-00	-	ZDL310240-50-00	ZDL310240-80-00	ZDL310240-100-00
transparent	€ 16,45	-	€ 19,95	€ 19,95	€ 19,95
Perforated Basket Insert	SIE280190-50	-	SIE310240-50-00	SIE310240-80-00	-
transparent	€ 16,45	-	€ 19,95	€ 19,95	-
Spit holder	-	-	-	-	-
black	-	-	-	-	-

Please add the color coding to the article number when ordering!

Prices plus VAT.

FOR STRIKING STAGINGS

Trays and Deep Trays Series NEO

with Compatible Accessories



The noblest way to make the best quality stand out more: Wide edges create space and add that extra class due to their fine-table surfaces. Use them to draw attention to products that are high-yielding, such as higher-priced quality products or goods from in-house production.

YOUR ADVANTAGES

- ✓ Framing edge shape
- ✓ Promotes serving character
- ✓ Grippy, rounded edges
- ✓ Perfectly combinable
- ✓ Glossy colors:
- ✓ Matte surfaces:



ACCESSORIES FOR SERIES NEO

Patented Honeycomb-Bottom Insert

- ✓ Preserve the natural color of the meat
- ✓ Replace the use of paper as a base
- ✓ Prevents meat discoloration for up to 72 hours (for beef)
- ✓ Matte surfaces:
- ✓ Glossy surfaces:



For more information, see Page 10 / 11.

Inlays / insert plates

- ✓ For beautiful visual accents
- ✓ Particularly natural look
- ✓ Can be customized using laser technology
- ✓ Slate and Wood look:



Trays and Deep Trays Series NEO

with Compatible Accessories



Dimensions in mm (L x W x H)	265 x 200 x 20	265 x 200 x 50	400 x 200 x 20
Volume	–	1.000 ml	–
Item no.	NEO265200-20	NEO265200-50	NEO400200-20
white glossy	0 -10 € 23,95	€ 23,95	€ 25,95
black glossy	1 -02 € 23,95	€ 23,95	€ 25,95
champagne gl.	2 -12 € 23,95	€ 23,95	€ 25,95
graphite stone	3 -25 € 23,95	€ 23,95	€ 25,95
petrol stone	4 -28 –	–	–
white matt	5 -70 € 23,95	€ 23,95	€ 25,95
black matt	6 -72 € 23,95	€ 23,95	€ 25,95

Compatible Accessories:

Honeycomb-Bottom Insert	WBEN265200-20	WBEN265200-50	WBEN400200-20
white matt	0 -10 € 15,45	€ 15,45	€ 19,95
black matt	1 -72 € 15,45	€ 15,45	€ 19,95
green matt	2 -74 € 15,45	€ 15,45	€ 19,95
red matt	3 -75 € 15,45	€ 15,45	€ 19,95

Inlay/insert plate	INNEO265200-20	INNEO265200-50	INNEO400200-20
Slate look	1 -82 € 16,95	€ 16,95	€ 19,95
Wood look	2 -85 € 16,95	€ 16,95	€ 19,95

Please add the color coding to the article number when ordering!

Prices plus VAT.

HYGIENE TIP

Fulfill hygiene regulations in a simple, practical way with our Panel Divider System. Available for Display Tray and Deep Tray 265 x 200 mm.

For details, see Page 135.

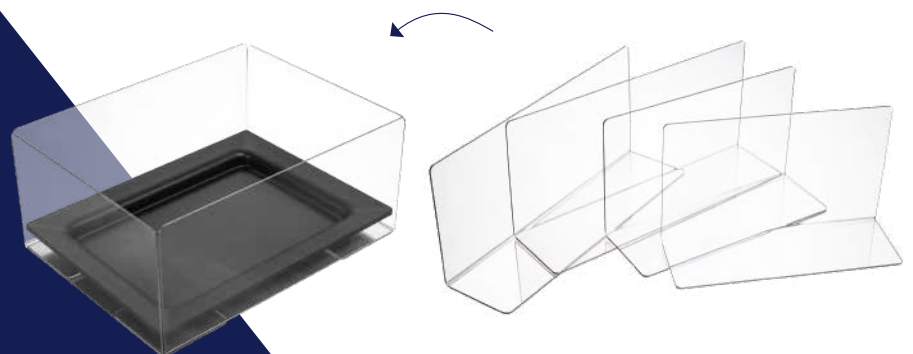

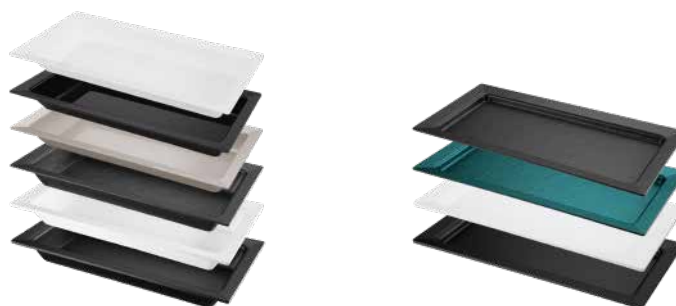

Dimensions in mm (LxWxH)	400 x 200 x 50		400 x 265 x 20	
Volume	1.900 ml		-	
Item no.	NEO400200-50		NEO400265-20	
white glossy	0	-10	€ 25,95	-
black glossy	1	-02	€ 25,95	-
champagne gl.	2	-12	€ 25,95	-
graphite stone	3	-25	€ 25,95	€ 35,95
petrol stone	4	-28	-	€ 35,95
white matt	5	-70	€ 25,95	€ 35,95
black matt	6	-72	€ 25,95	€ 35,95

Compatible Accessories:

Honeycomb-Bottom Insert		WBEN400200-50	WBEN400265-20
white matt	0	-10	€ 19,95
black matt	1	-72	€ 19,95
green matt	2	-74	€ 19,95
red matt	3	-75	€ 19,95
Inlay/insert plate		INNEO400200-50	INNEO400265-20
Slate look	1	-82	€ 19,95
Wood look	2	-85	€ 19,95

Please add the color coding to the article number when ordering!

Prices plus VAT.

Trays and Deep Trays Series NEO

with Compatible Accessories

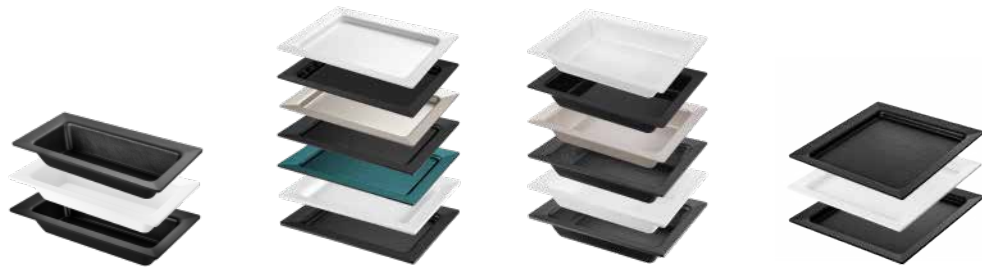

Dimensions in mm (L x W x H)	280 x 140 x 50	280 x 210 x 20	280 x 210 x 50	280 x 280 x 20
Volume	700 ml	–	1.300 ml	–
Item no.	NEO280140-50	NEO280210-20	NEO280210-50	NEO280280-20
white glossy	0 -10 –	€ 23,95	€ 23,95	–
black glossy	0 -02 –	€ 23,95	€ 23,95	–
champagne gl.	0 -12 –	€ 23,95	€ 23,95	–
graphite stone	0 -25 € 23,95	€ 23,95	€ 23,95	€ 23,95
petrol stone	0 -28 –	€ 23,95	–	–
white matt	0 -70 € 23,95	€ 23,95	€ 23,95	€ 23,95
black matt	0 -72 € 23,95	€ 23,95	€ 23,95	€ 23,95

Compatible Accessories:

Honeycomb-Bottom Insert	WBEN280140-50	WBEN280210-20	WBEN280210-50	WBEN280280-20
white matt	0 -10 € 15,95	€ 15,95	€ 15,95	€ 15,95
black matt	0 -72 € 15,95	€ 15,95	€ 15,95	€ 15,95
green matt	0 -74 € 15,95	€ 15,95	€ 15,95	€ 15,95
red matt	0 -75 € 15,95	€ 15,95	€ 15,95	€ 15,95

Inlay/insert plate	INNEO280140-50	INNEO280210-20	INNEO280210-50	INNEO280280-20
Slate look	0 -82 € 16,95	€ 16,95	€ 16,95	€ 16,95
Wood look	0 -85 € 16,95	€ 16,95	€ 16,95	€ 16,95

Please add the color coding to the article number when ordering!

Prices plus VAT.

HYGIENE TIP

Fulfill hygiene regulations in a simple, practical way with our Panel Divider System. Available for Display Tray and Deep Tray 280 x 210 mm and 420 x 280 mm.

For details, see Page 135.

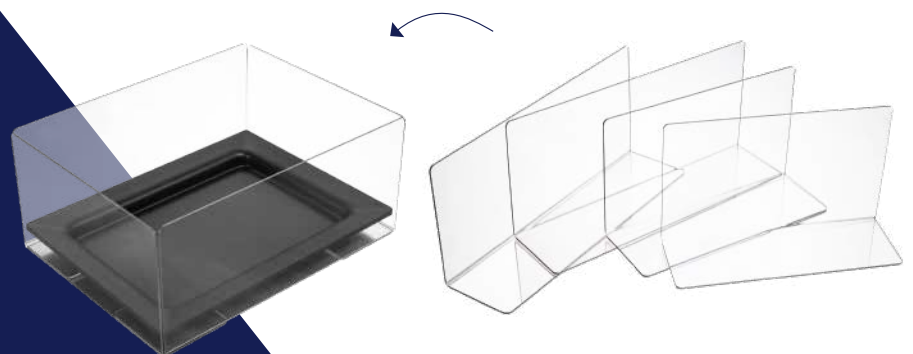

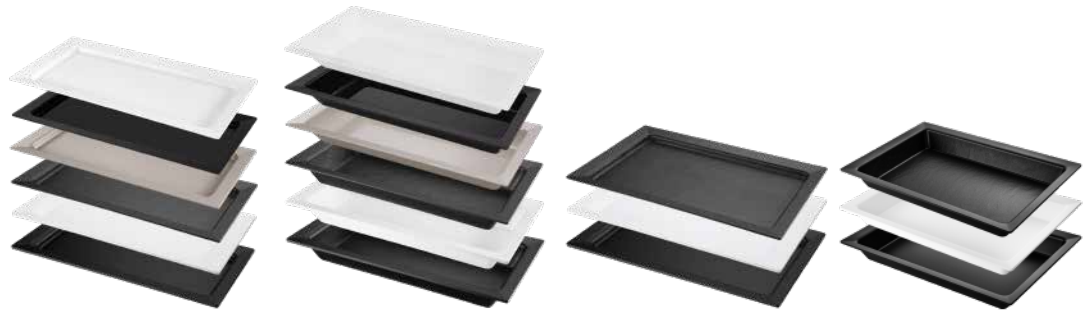

Dimensions in mm (LxWxH)	420 x 210 x 20	420 x 210 x 50	420 x 280 x 20	420 x 280 x 50
Volume	-	2.100 ml	-	3.000 ml
Item no.	NEO420210-20	NEO420210-50	NEO420280-20	NEO420280-50
white glossy	0 -10 € 26,95	€ 26,95	-	-
black glossy	1 -02 € 26,95	€ 26,95	-	-
champagne gl.	2 -12 € 26,95	€ 26,95	-	-
graphite stone	3 -25 € 26,95	€ 26,95	€ 35,95	€ 35,95
petrol stone	4 -28 -	-	-	-
white matt	5 -70 € 26,95	€ 26,95	€ 35,95	€ 35,95
black matt	6 -72 € 26,95	€ 26,95	€ 35,95	€ 35,95

Compatible Accessories:

Honeycomb-Bottom Insert	WBEN420210-20	WBEN420210-50	WBEN420280-20	WBEN420280-50
white matt	7 -10 € 19,95	€ 19,95	€ 23,95	€ 23,95
black matt	8 -72 € 19,95	€ 19,95	€ 23,95	€ 23,95
green matt	9 -74 € 19,95	€ 19,95	€ 23,95	€ 23,95
red matt	10 -75 € 19,95	€ 19,95	€ 23,95	€ 23,95
Inlay/insert plate	INNEO420210-20	INNEO420210-50	INNEO420280-20	INNEO420280-50
Slate look	11 -82 € 19,95	€ 19,95	€ 24,95	€ 24,95
Wood look	12 -85 € 19,95	€ 19,95	€ 24,95	€ 24,95

Please add the color coding to the article number when ordering!

Prices plus VAT.

TIPS & TRICKS

In a uniform presentation of goods, colorful delicatessen products and salads appear organized and tidy. A matt white color finish has the appearance of fine porcelain.



Trays and Deep Trays Series NEO

with Compatible Accessories



Dimensions in mm (L x W x H)	265 x 200 x 20		265 x 200 x 50	
GN	1/5		1/5	
Volume	-		1.000 ml	
Item no.	NEO265200-20		NEO265200-50	
white glossy	-10	€ 23,95		€ 23,95
black glossy	-02	€ 23,95		€ 23,95
champagne gl.	-12	€ 23,95		€ 23,95
graphite stone	-25	€ 23,95		€ 23,95
white matt	-70	€ 23,95		€ 23,95
black matt	-72	€ 23,95		€ 23,95

Compatible Accessories:

Honeycomb-Bottom Insert	WBEN265200-20		WBEN265200-50	
white matt	-70	€ 15,45		€ 15,45
black matt	-72	€ 15,45		€ 15,45
green matt	-74	€ 15,45		€ 15,45
red matt	-75	€ 15,45		€ 15,45
Inlay/insert plate	INNEO265200-20		INNEO265200-50	
Slate look	-82	€ 16,95		€ 16,95
Wood look	-85	€ 16,95		€ 16,95

Please add the color coding to the article number when ordering!

Prices plus VAT.

HYGIENE TIP

Fulfill hygiene regulations in a simple, practical way with our Panel Divider System. Available for Display Tray and Deep Tray 265 x 200 mm.

For details, see Page 135.

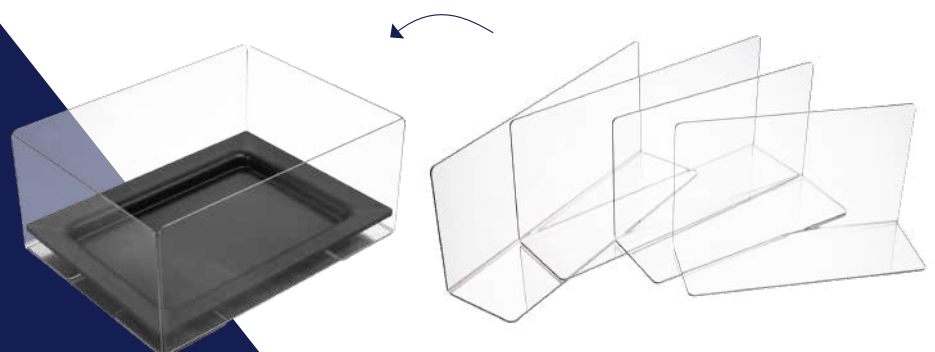



EXPERT TIP



Christian Priebe
Managing Director
PricoPlex

The wood-look inlay boards are ideal for presenting regional delicacies and home-made products. The result is a recommendation and specialty character.

THE BASIC SOLUTION

Display Trays Series ECO

with Compatible Accessories



The ideal basis for the best possible space utilization in your deli counter. Choose the Series ECO if you want to occupy every corner of your display and at the same time prefer a tidy, structured counter design.



YOUR ADVANTAGES

- ✓ Especially space saving
- ✓ Reinforced edge
- ✓ Glossy colors: 



ACCESSORIES FOR SERIES ECO

Patenterte Honeycomb-Bottom Insert

- ✓ Preserve the natural color of the meat
- ✓ Replace the use of paper as a base
- ✓ Prevents meat discoloration for up to 72 hours (for beef)
- ✓ Matte surfaces: 
- ✓ Glossy surfaces: 

You can find more information on Page 10/11.



Spit holder

- ✓ Precisely and neatly presented
- ✓ Perfect for preparation
- ✓ Suitable for all common skewers
- ✓ Firm stand due to conical bore
- ✓ Handle for practical removal



View
Handle
Back side



Display Trays Series ECO

with Compatible Accessories



Dimensions in mm (L x W x H)		210 x 140 x 20	280 x 140 x 20	280 x 210 x 20	280 x 280 x 20
Volume		–	–	–	–
Item no.		SAO210140	SAO280140	PPA280210	PPA280280
white glossy	□ -10	€ 14,45	€ 15,95	€ 16,95	€ 21,45
black glossy	■ -02	€ 14,45	€ 15,95	€ 16,95	€ 21,45
green glossy	■ -04	–	€ 15,95	€ 16,95	€ 21,45
red glossy	■ -05	–	€ 15,95	€ 16,95	€ 21,45
yellow glossy	■ -06	–	–	€ 16,95	€ 21,45
blue transparent	■ -07	–	–	€ 16,95	–

Compatible Accessories:

Honeycomb-Bottom Insert	WBE210140-20	WBE280140	WBE280210	WBE280280	
white matt	□ -70	€ 14,95	€ 15,95	€ 16,95	€ 18,95
black matt	■ -72	€ 14,95	€ 15,95	€ 16,95	€ 18,95
green matt	■ -74	€ 14,95	€ 15,95	€ 16,95	€ 18,95
red matt	■ -75	€ 14,95	€ 15,95	€ 16,95	€ 18,95
Spit holder	–	–	SPH280210-02	–	
black	–	–	€ 20,95	–	

Please add the color coding to the article number when ordering!

Prices plus VAT.

HYGIENE TIP

Fulfill hygiene regulations in a simple, practical way with our Panel Divider System. Available for Display Tray and Tray 280 x 210 mm and 420 x 280 mm.

For details, see Page 135.

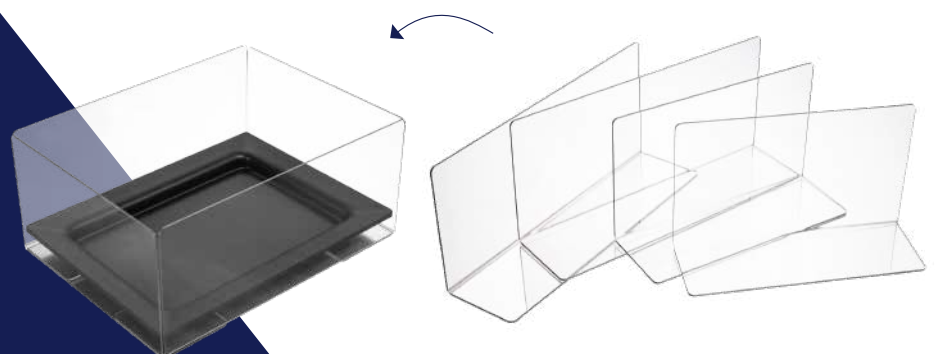



Dimensions in mm (LxWxH)		420 x 140 x 20	420 x 210 x 20	420 x 280 x 20
Volume		–	–	–
Item no.		SAO420140	SAO420210	PPA420280
white glossy	□ -10	€ 19,45	€ 20,95	€ 22,95
black glossy	■ -02	€ 19,45	€ 20,95	€ 22,95
green glossy	■ -04	–	€ 20,95	€ 22,95
red glossy	■ -05	–	€ 20,95	€ 22,95
yellow glossy	■ -06	–	–	€ 22,95
blue transparent	■ -07	–	–	€ 22,95

Compatible Accessories:

Honeycomb-Bottom Insert		WBE420140	WBE420210	WBE420280
white matt	□ -70	€ 15,95	€ 19,95	€ 20,95
black matt	■ -72	€ 15,95	€ 19,95	€ 20,95
green matt	■ -74	€ 15,95	€ 19,95	€ 20,95
red matt	■ -75	€ 14,95	€ 19,95	€ 20,95
Spit holder		–	–	–
black		–	–	–

Please add the color coding to the article number when ordering!

Prices plus VAT.

Other sizes

popular sizes outside the standard systems

Display Trays Series ECO

with Compatible Accessories



Dimensions in mm (L x W x H)	250 x 150 x 20	250 x 190 x 20	300 x 200 x 20	310 x 240 x 20	350 x 240 x 20
Volume	-	-	-	-	-
Item no.	SAO250150	SAO250190	SAO300200	SAO310240	SAO350240
white glossy	0 -10 € 14,95	€ 15,45	€ 16,95	€ 21,95	€ 22,95
black glossy	1 -02 € 14,95	€ 15,45	€ 16,95	€ 21,95	€ 22,95
green glossy	2 -04 -	-	-	-	-
red glossy	3 -05 -	-	-	-	-
yellow glossy	4 -06 -	-	-	-	-
blue transparent	5 -07 -	-	-	-	-

Compatible Accessories:

Honeycomb-Bottom Insert	-	-	-	-	-
white matt	6 -70 -	-	-	-	-
black matt	7 -72 -	-	-	-	-
Spit holder	-	-	-	-	-
black	-	-	-	-	-

Please add the color coding to the article number when ordering!

Prices plus VAT.



Other sizes

popular sizes outside the standard systems



Dimensions in mm (L x W x H)		380 x 280 x 20	580 x 210 x 20
Volume		–	–
Item no.		SAO380280	SAO580210
white glossy	-10	€ 22,95	€ 27,95
black glossy	-02	€ 22,95	€ 27,95
green glossy	-04	–	–
red glossy	-05	–	–
yellow glossy	-06	–	–
blue transparent	-07	–	–

Compatible Accessories:

Honeycomb-Bottom Insert		–	–
white matt	-70	–	–
black matt	-72	–	–
Spit holder		–	–
black		–	–

Please add the color coding to the article number when ordering!

Prices plus VAT.

EXPERT TIP



Fritz Gempel
Management Consultant
and Master Butcher

Small counters are best equipped with space-saving Display Trays to avoid wasting space. A narrow edge promotes a dense arrangement without making the display look crowded.

If you still lack space, you can use Layered Displays to expand your display area to offer snacks outside the counter. This has a close-up effect and significantly increases customer attention.

SUBSTRUCTURES FOR BEST UTILIZATION

Stepped Displays

with Compatible Accessories



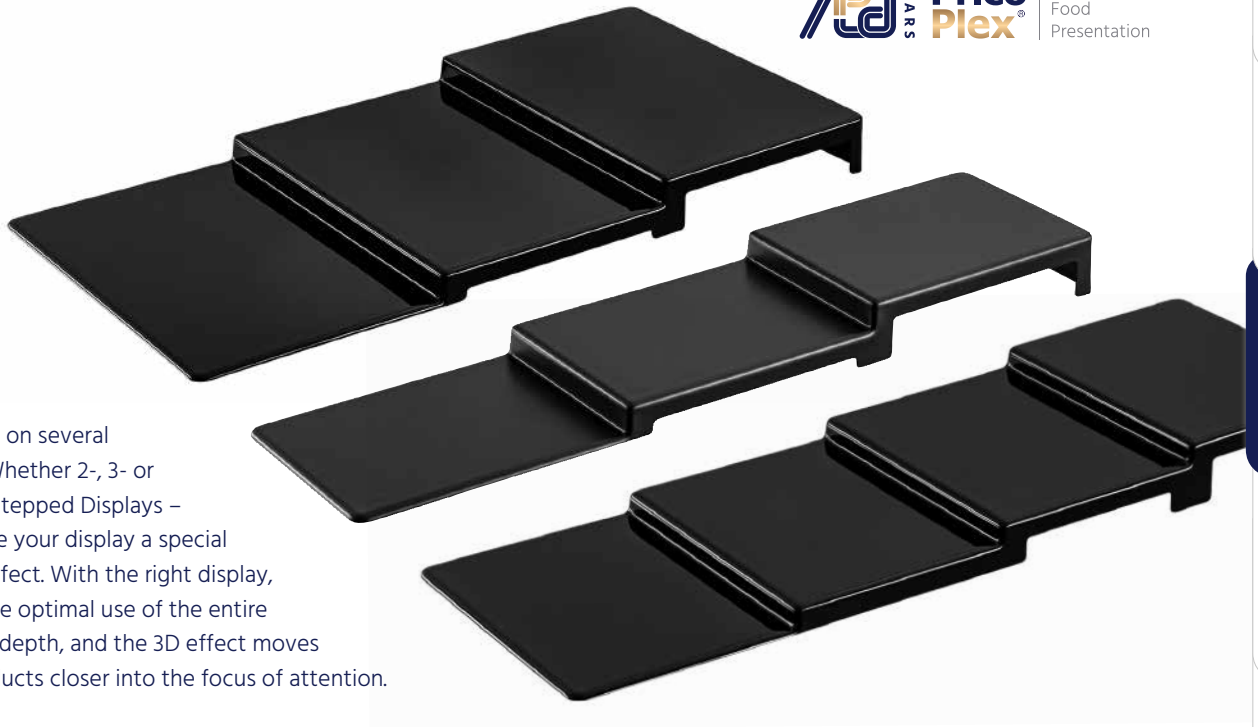

An asset on several levels: Whether 2-, 3- or 4-level Stepped Displays – they give your display a special depth effect. With the right display, you make optimal use of the entire counter depth, and the 3D effect moves the products closer into the focus of attention.

YOUR ADVANTAGES

- ✓ Best use of counter depth
- ✓ For increased customer attention
- ✓ Easy handling



black glossy
-02



graphite stone
-25



black matt
-72

COMPATIBLE ACCESSORIES

Decor panel in wood and Slate look

- ✓ For beautiful visual accents
- ✓ Particularly natural look
- ✓ Can be customized using laser technology
- ✓ Slate and Wood look: 



Transparent dividers

- ✓ For clear separation of goods
- ✓ Durable acrylic glass
- ✓ Stabilizer bars for high stability

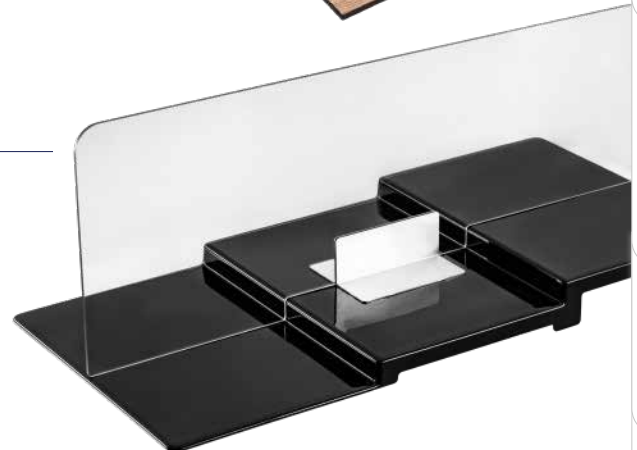

Stepped Displays with Compatible Accessories



Dimensions in mm (L x W x H)	800 x 400 x 60	800 x 100 x 60	800 x 200 x 60
Levels	2 Ebenen 5/30 mm	3 Ebenen 5/30/60 mm	3 Ebenen 5/30/60 mm
Item no.	TD80040060-2	TD80010060-3	TD80020060-3
black glossy	█ -02 -	-	-
black matt	█ -72 -	-	€ 113,95
graphite stone	█ -25 € 113,95	€ 59,95	€ 113,95

Compatible Accessories:

Decor plate	-	-	-
Slate look	█ -82 -	-	-
Wood look	█ -85 -	-	-
Divider	-	-	TS80040060-3-00
transparent	-	-	€ 119,95

Please add the color coding to the article number when ordering!

Prices plus VAT.



TIPS & TRICKS

Stepped Displays have the advantage that they are removable and therefore easy to clean. The closed form of the steps ensures that the merchandise floor displays get much less dirty.

Different heights promise a lively, spot-on presentation. The displays are also an asset freestanding, for example at the buffet.

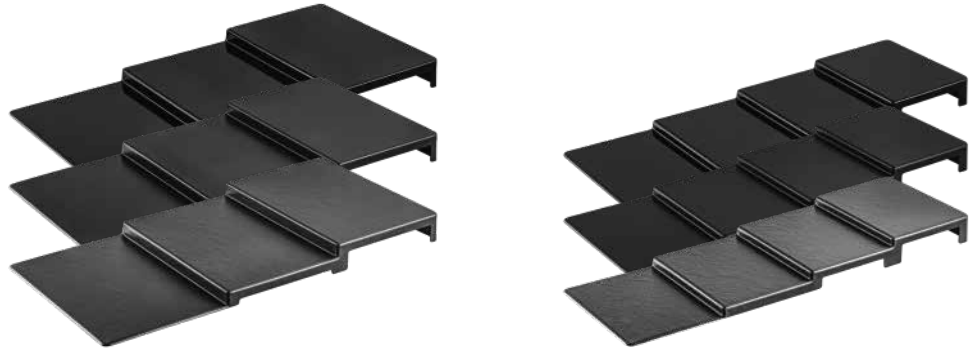

Dimensions in mm (LxWxH)	800 x 400 x 60	800 x 265 x 60
Levels	3 Ebenen 5/30/60 mm	4 Ebenen 5/25/40/60 mm
Item no.	TD80040060-3	TD80026560-4
black glossy	02 € 113,95	€ 89,95
black matt	72 € 113,95	€ 89,95
graphite stone	25 € 113,95	€ 89,95

Compatible Accessories:

Decor plate	ST400265	ST265200
Slate look	82 € 44,95	€ 20,95
Wood look	85 € 44,95	€ 20,95
Divider	TS80040060-3-00	-
transparent	€ 119,95	-

Prices plus VAT.



Stepped Displays with Compatible Accessories

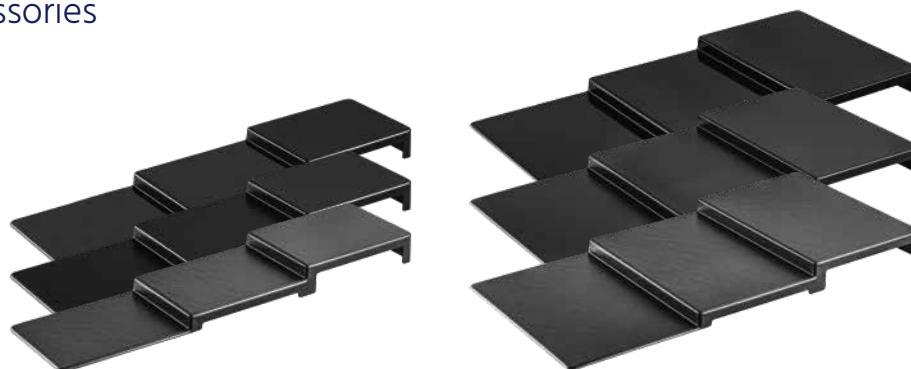

Dimensions in mm (L x W x H)	840 x 210 x 60	840 x 420 x 60
Levels	3 Levels 5/30/60 mm	3 Levels 5/30/60 mm
Item no.	TD84021060-3	TD84042060-3
black glossy	02 € 79,95	€ 113,95
black matt	72 € 79,95	€ 113,95
graphite stone	25 € 79,95	€ 113,95

Compatible Accessories:

Decor plate	ST210280	ST420280
Slate look	82 € 22,95	€ 47,95
Wood look	85 € 22,95	€ 47,95
Divider	-	TS84042060-3-00
transparent	-	€ 119,95

Please add the color coding to the article number when ordering!

Prices plus VAT.

HYGIENE TIP

For the Stepped Display, panel dividers can be inserted and repositioned in no time at all.



SY
8.4

Modular system 8.4

optimal for displays in counter depths between 840 – 870 mm

70 YEARS
Prico
Plex®

Professional
Food
Presentation

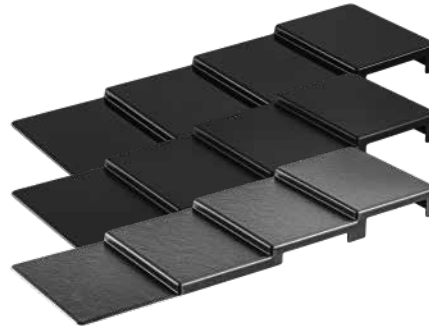

Dimensions in mm (L x W x H)		840 x 280 x 60	
Levels		4 Levels 5/25/40/60 mm	
Item no.		TD84028060-4	
black glossy	▬ -02	€ 89,95	
black matt	▬ -72	€ 89,95	
graphite stone	▬ -25	€ 89,95	

Compatible Accessories:

Decor plate		ST210280	
Slate look	▬ -82	€ 22,95	
Wood look	▬ -85	€ 22,95	
Divider		-	
transparent			-

Please add the color coding to the article number when ordering!

Prices plus VAT.



Stepped Display with Display Tray NEO
280 x 210 x 20 mm in white glossy
(Item No. NEO280210-20-10)

HIGH-VOLUME ALL-ROUNDER

Salad and Deli Trays Series CASUAL

with Salad Tray Carriers
and Compatible Accessories



Fresh produce presented in a value-added way – square Display Trays for salads, spreads, Mediterranean food, or delicatessen items. Thanks to the high-quality design, even larger presentation volumes have a classy presentation. Perfect for top sellers, specials and sales, or the hot counter.

YOUR ADVANTAGES

- ✓ Can be used in the fresh food counter or as tableware
- ✓ Excellent for block formation
- ✓ Space-saving due to narrow edge
- ✓ Glossy colors: 



COMPATIBLE ACCESSORIES FOR SERIES CASUAL

Inserter / reduction insert

Practical use for reducing Salad Trays to a volume of one liter.

- ✓ Easily compensate for filling differences
- ✓ Uniform appearance is maintained
- ✓ Glossy colors: 



Lid

Optimal for keeping fresh or as a night cover: Matching Lid to make Salad Trays stackable and thus save space in storage.

- ✓ Closes reliably and keeps tight
- ✓ Good handle for quick opening
- ✓ Stackable and space saving storage



Salad bowl carrier in Slate look

High quality carrier for one, two or four bowls. It guarantees you easy removal of goods, durable appearance and fixed arrangement, because the salad bowl is locked.

- ✓ In different heights
- ✓ With anti-slip rubber feet
- ✓ Attractive Slate look



Salad and Deli Trays Series CASUAL

with Compatible Accessories



Dimensions in mm (L x W x H)	200 x 100 x 70	200 x 200 x 70	270 x 270 x 90
Volume	800 ml	1.900 ml	4.500 ml
Item no.	PPB200100-70	PPB200200-70	PPB270270-90
white glossy	☐ -10 € 15,95	€ 21,95	€ 30,95
clear transparent	☐ -00 -	€ 21,95	-
black glossy	☐ -02 € 15,95	€ 21,95	€ 30,95
red glossy	☐ -05 -	€ 21,95	€ 30,95
blue transparent	☐ -07 -	€ 21,95	-

Compatible Accessories:

Inserters / reduction insert	-	PPB200200-42 (900 ml)	SAB270270-42 (2.000 ml)
white glossy	☐ -10 -	€ 14,95	€ 20,95
clear transparent	☐ -00 -	€ 14,95	-
black glossy	☐ -02 -	€ 14,95	€ 20,95
red glossy	☐ -05 -	€ 14,95	€ 20,95
blue transparent	☐ -07 -	€ 14,95	-
Lid	-	ZDO200200-50-00	ZDO270270-50-00
transparent	-	€ 18,95	€ 24,95

Please add the color coding to the article number when ordering!

Prices plus VAT.



Small, flexible, fine: the new bowls series CASUAL range are half as wide as their „big sisters“ at 200 x 100 x 70 mm.

This allows you to present your salads and delicatessen specialties even more flexibly and in different quantities.

Salad Tray Carriers in Slate look for Series CASUAL

with slip resistant feet



Dimensions in mm (LxW)		270 x 270	410 x 200	410 x 410
Bracket for		1 x Deep Trays PPB270270-90	2 x Deep Trays PPB200200-70	4 x Deep Trays PPB200200-70
Item no.		SST270270	SST410200	SST410410
Height 15 mm	-15	€ 46,95	€ 61,95	€ 97,95
Height 30 mm	-30	€ 47,95	€ 62,95	€ 98,95
Height 40 mm	-40	€ 48,95	€ 63,95	€ 99,95
Height 50 mm	-50	€ 49,95	€ 64,95	€ 100,95
Height 60 mm	-60	€ 50,95	€ 65,95	€ 101,95
Height 80 mm	-80	€ 51,95	€ 66,95	€ 102,95

Please add the coding for Height to the article no. when ordering!

Prices plus VAT.



Available in different heights

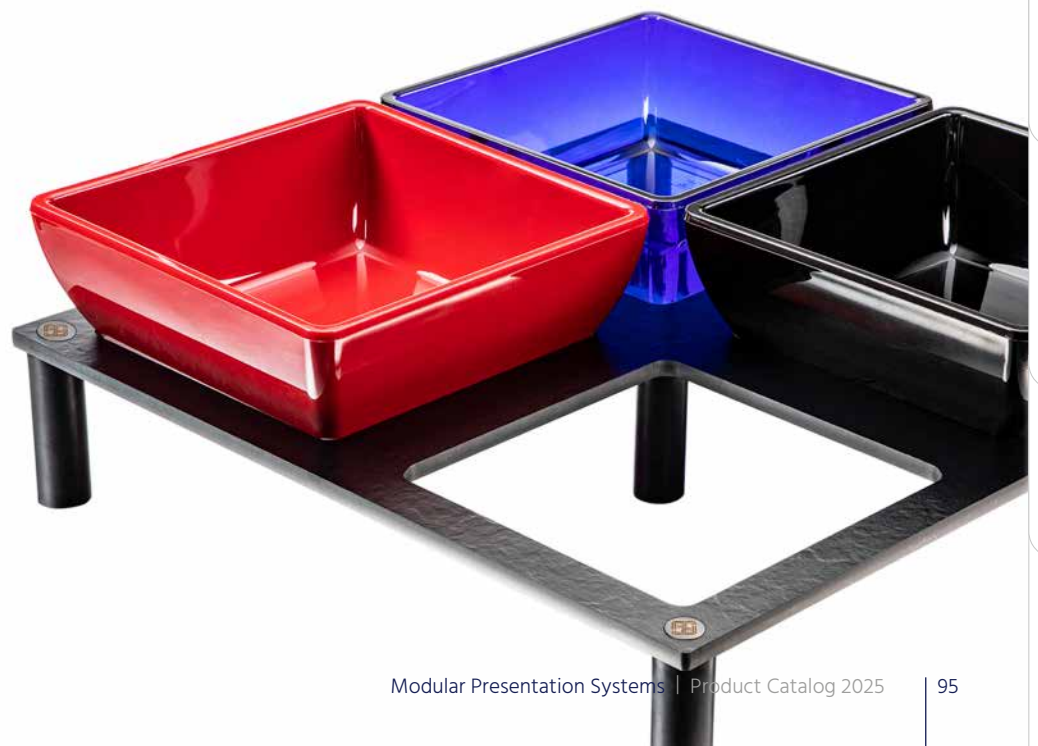

Salad and Deli Trays Series CASUAL

with Compatible Accessories



Dimensions in mm (L x W x H)	200 x 100 x 70	200 x 200 x 70	270 x 270 x 90
Volume	800 ml	1.900 ml	4.500 ml
Item no.	PPB200100-70	PPB200200-70	PPB270270-90
white glossy	-10 € 15,95	€ 21,95	€ 30,95
clear transparent	-00 -	€ 21,95	-
black glossy	-02 € 15,95	€ 21,95	€ 30,95
red glossy	-05 -	€ 21,95	€ 30,95
blue transparent	-07 -	€ 21,95	-

Compatible Accessories:

Inserters / reduction insert	-	PPB200200-42 (900 ml)	SAB270270-42 (2.000 ml)
white glossy	-10 -	€ 14,95	€ 20,95
clear transparent	-00 -	€ 14,95	-
black glossy	-02 -	€ 14,95	€ 20,95
red glossy	-05 -	€ 14,95	€ 20,95
blue transparent	-07 -	€ 14,95	-
Lid	-	ZDO200200-50-00	ZDO270270-50-00
transparent	-	€ 18,95	€ 24,95

Please add the color coding to the article number when ordering!

Prices plus VAT.



Small, flexible, fine: the new bowls series CASUAL range are half as wide as their „big sisters“ at 200 x 100 x 70 mm.

This allows you to present your salads and delicatessen specialties even more flexibly and in different quantities.

Salad Tray Carriers in Slate look for Series CASUAL

with slip resistant feet



Dimensions in mm (LxW)		280 x 280	420 x 210	420 x 420
Bracket for		1 x Deep Trays PPB270270-90	2 x Deep Trays PPB200200-70	4 x Deep Trays PPB200200-70
Item no.		SST280280	SST420210	SST420420
Height 15 mm	-15	€ 46,95	€ 61,95	€ 97,95
Height 30 mm	-30	€ 47,95	€ 62,95	€ 98,95
Height 40 mm	-40	€ 48,95	€ 63,95	€ 99,95
Height 50 mm	-50	€ 49,95	€ 64,95	€ 100,95
Height 60 mm	-60	€ 50,95	€ 65,95	€ 101,95
Height 80 mm	-80	€ 51,95	€ 66,95	€ 102,95

Please add the code for Height to the article number when ordering!

Prices plus VAT.

TIPS & TRICKS

Salad Tray Carriers create consistent spacing and prevent slipping when removing goods. Order the lid right away to store your delicatessen salads in the best possible way.



EYE-CATCHERS FOR YOUR COUNTER

Salad and Deli Trays Series FRAME



What do your beautiful, delicious products need in order to fresh food counter even better? That's right: They need a frame. Our new salad and deli trays give your food offerings that certain something, like a work of art that is perfectly staged with the right frame. With variants in green and orange, we also bring fresh colors into play.

YOUR ADVANTAGES

- ✓ Can be used in the fresh food counter or as tableware
- ✓ For excellent block formation
- ✓ Space-saving due to narrow edge
- ✓ Carrier in high-quality slate or wood look, green or orange

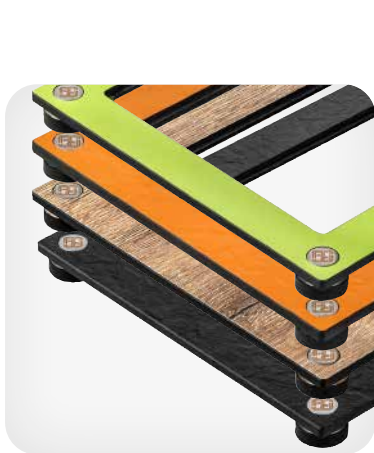

In high-quality surfaces



With branding through laser technology

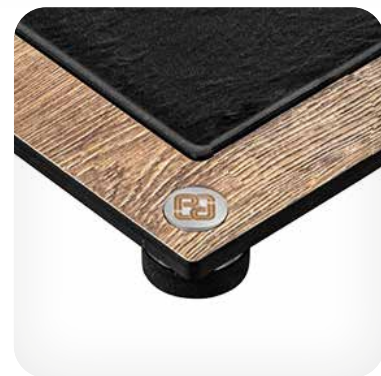

With non-slip cleats

COMPATIBLE ACCESSORIES FOR SERIES FRAME

Trays and deep Trays

- ✓ Sleek and Elegant
- ✓ Adds a noble touch
- ✓ For decorative presentation
- ✓ Matte surfaces: ● ○ ●

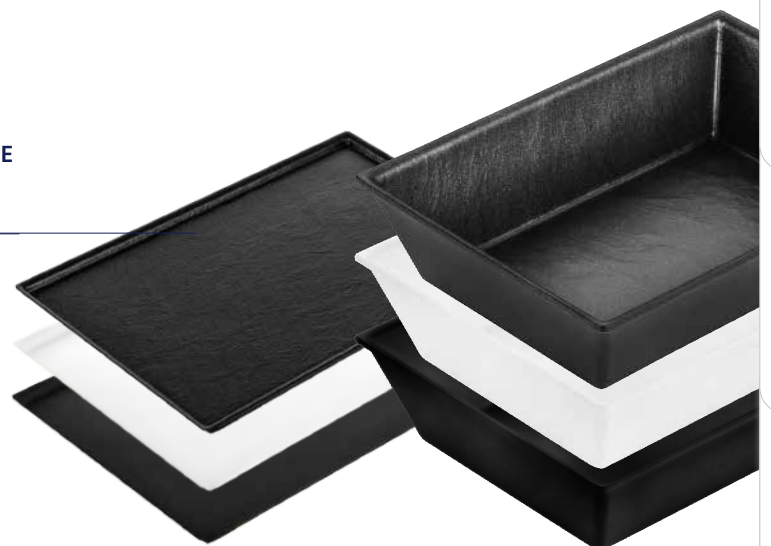

Salad and Deli Trays

Series FRAME

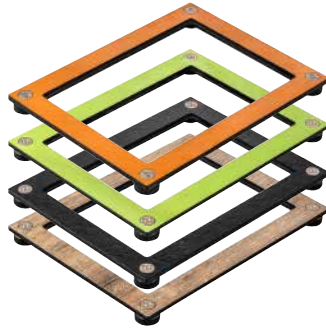

Dimensions in mm (L x W x H)	265 x 200 x 15	265 x 200 x 40
Item no.	VEGR265200-15	VEGR265200-40
orange	-83 € 29,95	€ 29,95
green	-84 € 29,95	€ 29,95
Slate look	-82 € 29,95	€ 29,95
Wood look	-85 € 29,95	€ 29,95

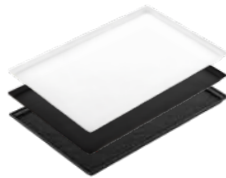

Compatible Accessories:

Trays and deep Trays:	VEGP215150-10	VEGB215150-50 (900 ml)
white matt	-70 € 15,95	€ 15,95
black matt	-71 € 15,95	€ 15,95
graphite stone	-25 € 15,95	€ 15,95

Please add the color coding to the article number when ordering!

Prices plus VAT.

TIPS & TRICKS

Whether black or white: the Trays and deep Trays can be replaced in a single step and the frame is given a new look. This means you can customize your fresh food counter at any time. Another advantage is that you can quickly transfer prepared Trays from the chiller to the counter. This means that there are no gaps even when there are large numbers of customers.



SY
8.0

Modular system 8.0

optimal for displays in counter depths between 800 – 840 mm

70 YEARS
Prico
Plex®

Professional
Food
Presentation

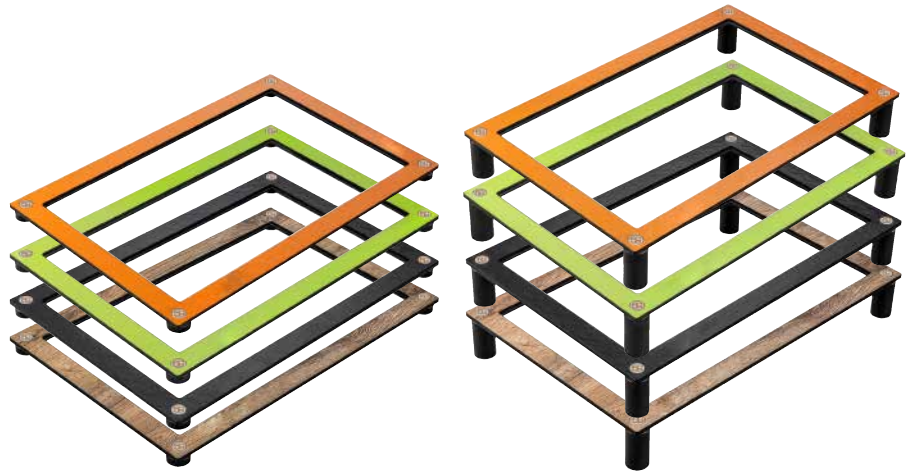

Dimensions in mm (L x W x H)	400 x 265 x 15	400 x 265 x 40
Item no.	VEGR400265-15	VEGR400265-40
orange	€ 32,95	€ 32,95
green	€ 32,95	€ 32,95
Slate look	€ 32,95	€ 32,95
Wood look	€ 32,95	€ 32,95

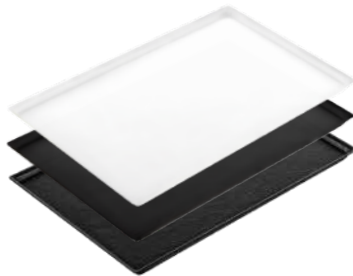

Compatible Accessories:

Trays and deep Trays:	VEGP310215-10	-
white matt	€ 18,95	-
black matt	€ 18,95	-
graphite stone	€ 18,95	-

Please add the color coding to the article number when ordering!

Prices plus VAT.

ORGANICALLY SHAPED

Salad and Deli Trays



Series FRESH

with Compatible Accessories



This shape recalls mother's home cooking, when the freshly prepared casserole is served and the whole family sits down to eat together. The simple elegance of the oval shape emphasizes this effect in the counter and buffet alike. For salads, delicatessen, stews ...

YOUR ADVANTAGES

- ✓ Narrow edge for efficient topping
- ✓ Can be used in the fresh food counter or as tableware
- ✓ Glossy colors:  



Dimensions in mm (L x W x H)	310 x 168 x 30	310 x 168 x 70	420 x 210 x 40	420 x 210 x 70	600 x 220 x 40
Volume	800 ml	1.600 ml	1.500 ml	2.600 ml	2.500 ml
Item no.	SBO310168-30	SBO310168-70	SBO420210-40	SBO420210-70	SBO600220-40
white glossy  -10	€ 19,95	€ 20,95	€ 22,95	€ 23,95	€ 31,95
black glossy  -02	€ 19,95	€ 20,95	€ 22,95	€ 23,95	€ 31,95

Compatible Accessories:

Lid with Spoon Recess	ZDL310168-30-00	ZDL310168-70-00	-	-	-
transparent	€ 19,45	€ 19,45	-	-	-

Preisangaben zzgl. MwSt.

TIPS & TRICKS

Colored creations are particularly effective in the white deli Trays. And the Trays themselves underline the quality of your high-quality products with their ceramic appearance.



CREATE MORE OVERVIEW

Layered Curved Displays

with Compatible Accessories



An attractive, sales platform offering the best overview of product range: With our Layered Curved Displays, create layered displays that allow your full selection of specialties to be taken in at a glance. Whether as a quarter or semicircle – the combinable display bowls and the shelf base in slate together create a classy and dazzling counter image.

YOUR ADVANTAGES

- ✓ Clear presentation of goods
- ✓ Stepped arrangement
- ✓ Increases customer attention
- ✓ High quality artificial slate for a qualitative presentation
- ✓ Glossy colors: ●
- ✓ Matte colors: ○

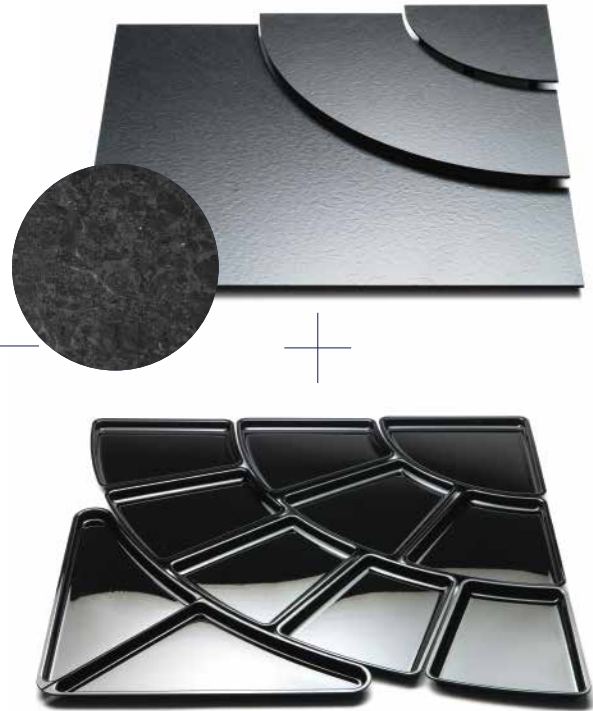

KEY DETAILS

Now even more flexibility in accessorizing your Layered Curved Display with Platters (20 mm depth), or create combinations of Display Trays and Deep Trays (40 mm depth), depending on the contents needed for each tier.



EXPERT TIP



Daniel Walther
PricoPlex
Customer Consultant

Use Layered Curved Displays and matching Display Trays. For a successful project launch, a prime spot in the display with the label “New Offering,” as well as tasting promotions are suitable.



Layered Curved Displays

with Compatible Accessories

Dimensions in mm (L x W)	800 x 800 (1/4 Circle)
Levels	3 Levels with 15/40/60 mm
Item no.	ETU14800800-82
Slate look	€ 319,00

Compatible Accessories:

Layered Displays Tray Combi; depth 20 mm	ETP14800800-20	
Consisting of	11-piece: 1 x E280280-20 3 x E280170-20 5 x E280190-20 1 x E700580/2-20	
black glossy	█ -02	€ 259,00
black matt	█ -72	€ 289,00
white matt	□ -70	€ 289,00
graphite stone	█ -25	€ 289,00
Layered Displays Tray Combi; depth 40 mm	ETS14800800-40	
Consisting of	10-piece: 1 x E280280-40 3 x E280170-40 5 x E280190-40 1 x E700580-40	
black glossy	█ -02	€ 249,00
black matt	█ -72	€ 279,00
white matt	□ -70	€ 279,00
graphite stone	█ -25	€ 279,00

Please add the color coding to the article number when ordering!

Prices plus VAT.



Single Display Trays

Depth 20 mm

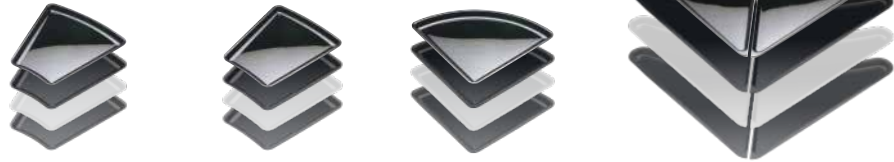

Dimensions in mm (LxWxH)	280 x 170 x 20	280 x 190 x 20	280 x 280 x 20	2 Stück: 350 x 580 x 20
Volume	–	–	–	–
Item no.	E280170-20	E280190-20	E280280-20	E700580/2-20
black glossy	02 € 22,95	€ 22,95	€ 22,95	€ 54,95
black matt	72 € 25,95	€ 25,95	€ 25,95	€ 59,95
white matt	70 € 25,95	€ 25,95	€ 25,95	€ 59,95
graphite stone	25 € 25,95	€ 25,95	€ 25,95	€ 59,95

Single Deep Trays

Depth 40 mm

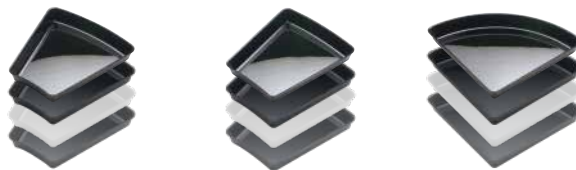

Dimensions in mm (LxWxH)	280 x 170 x 40	280 x 190 x 40	280 x 280 x 40
Volume	1.800 ml	1.700 ml	1.600 ml
Item no.	E280170-40	E280190-40	E280280-40
black glossy	02 € 22,95	€ 22,95	€ 22,95
black matt	72 € 25,95	€ 25,95	€ 25,95
white matt	70 € 25,95	€ 25,95	€ 25,95
graphite stone	25 € 25,95	€ 25,95	€ 25,95



Dimensions in mm (LxWxH)	700 x 580 x 40	2 Stück: 350 x 580 x 40
Volume	3.200 ml	gesamt 3.200 ml
Item no.	E700580-40	E700580/2-40
black glossy	02 € 41,95	€ 54,95
black matt	72 € 45,95	€ 59,95
white matt	70 € 45,95	€ 59,95
graphite stone	25 € 45,95	–

Please add the color coding to the article number when ordering!

Prices plus VAT.

Layered Curved Displays

with Compatible Accessories

Dimensions in mm (L x W)	840 x 840 (1/4 Kreis)
Levels	3 Levels with 15/40/60 mm
Item no.	ETU14840840-82
Slate look	€ 319,00

Compatible Accessories:

Layered Displays Tray Combi; depth 20 mm	ETP14840840-20	
bestehend aus Consisting of	11-piece:: 1 x E280280-20 3 x E280170-20 5 x E280190-20 1 x E700580/2-20	
black glossy	█ -02	€ 259,00
black matt	█ -72	€ 289,00
white matt	□ -70	€ 289,00
graphite stone	█ -25	€ 289,00
Layered Displays Tray Combi; depth 40 mm	ETS14840840-40	
Consisting of	10-piece:: 1 x E280280-40 3 x E280170-40 5 x E280190-40 1 x E700580-40	
black glossy	█ -02	€ 249,00
black matt	█ -72	€ 279,00
white matt	□ -70	€ 279,00
graphite stone	█ -25	€ 279,00

Please add the color coding to the article number when ordering!

Prices plus VAT.



Single Display Trays

Depth 20 mm



Dimensions in mm (L x W x H)	280 x 170 x 20	280 x 190 x 20	280 x 280 x 20	2 Piece: 350 x 580 x 20
Volume	-	-	-	-
Item no.	E280170-20	E280190-20	E280280-20	E700580/2-20
black glossy	02 € 22,95	€ 22,95	€ 22,95	€ 54,95
black matt	72 € 25,95	€ 25,95	€ 25,95	€ 59,95
white matt	70 € 25,95	€ 25,95	€ 25,95	€ 59,95

Single Deep Trays

Depth 40 mm



Dimensions in mm (L x W x H)	280 x 170 x 40	280 x 190 x 40	280 x 280 x 40
Volume	1.800 ml	1.700 ml	1.600 ml
Item no.	E280170-40	E280190-40	E280280-40
black glossy	02 € 22,95	€ 22,95	€ 22,95
black matt	72 € 25,95	€ 25,95	€ 25,95
white matt	70 € 25,95	€ 25,95	€ 25,95



Dimensions in mm (L x W x H)	700 x 580 x 40	2 Piece: 350 x 580 x 40
Volume	3.200 ml	total 3.200 ml
Item no.	E700580-40	E700580/2-40
black glossy	02 € 41,95	€ 54,95
black matt	72 € 45,95	€ 59,95
white matt	70 € 45,95	€ 59,95

Please add the color coding to the article number when ordering!

Prices plus VAT.

ALL-AROUND SUCCESSFUL INNOVATION

Circular Turntable Displays

with matching
individual elements



The eye-catcher that drives spontaneous purchases. The outstanding appearance offered by our Circular Turntable Displays gains an elegant and functional frame with the all-around stainless steel ring. Containers can be refilled and replaced easily and quietly, providing convenient support for counter staff. The Display Trays can be combined with each other and extended.



YOUR ADVANTAGES

- ✓ Variable Display Tray combinations
- ✓ Optimal also for counter angles
- ✓ Facilitates usability
- ✓ Increases customer attention

KEY DETAILS

- ✓ Easily reloadable base plate
- ✓ Railing made of high quality stainless steel
- ✓ Plate made of elegant artificial slate



Dimensions in mm (L x W)	800 x 800	800 x 800	800 x 800
Deep Trays Height	50 mm	80 mm	80 mm
Item no.	RKO780/01-02	RKO780/02-02	RKO780/03-02
Price	€ 789,00	€ 789,00	€ 849,00
Consisting of	Round plate 780 x 780 mm (total 800 x 800 mm) from Slate look with stainless steel railing incl. 13-piece Deep Tray set; Series FRESH (black glossy -02): 8 x Deep Trays 260 x 210 x 50 mm 1 x Deep Trays around 300 x 50 mm 4 x Deep Trays Triangle 350 x 260 x 50 mm	Round plate 780 x 780 mm (total 800 x 800 mm) from Slate look with stainless steel railing incl. 13-piece Deep Tray set; Series FRESH (black glossy -02): 8 x Deep Trays 260 x 210 x 80 mm 1 x Deep Trays around 300 x 80 mm 4 x Deep Trays Triangle 350 x 260 x 50 mm	Round plate 780 x 780 mm (total 800 x 800 mm) from Slate look with stainless steel railing incl. 15-piece Deep Tray set; Series FRESH (black glossy -02): 4 x Deep Trays 260 x 210 x 80 mm 6 x Deep Trays 210 x 180 x 80 mm 1 x Deep Trays around 300 x 80 mm 4 x Deep Trays Triangle 350 x 260 x 50 mm

Prices plus VAT.

Circular Turntable Displays Combination

Round plate incl. Deep Trays set



Dimensions in mm (L x W)	800 x 800	800 x 800	800 x 800
Deep Trays Height	80 mm	80 mm	80 mm
Item no.	RKO780/04-02	RKO780/05-02	RKO780/06-02
Price	€ 849,00	€ 789,00	€ 849,00 €
Consisting of	<p>Round plate 780 x 780 mm (total 800 x 800 mm) from Slate look with stainless steel railing</p> <p>incl. 17-piece Deep Trays set; Series FRESH (black glossy -02): 12 x Deep Trays 210 x 180 x 80 mm 1 x Deep Trays around 300 x 80 mm 4 x Deep Trays Triangle 350 x 260 x 50 mm</p>	<p>Round plate 780 x 780 mm (total 800 x 800 mm) from Slate look with stainless steel railing</p> <p>incl. 14-piece Deep Trays set; Series FRESH (black glossy -02): 8 x Deep Trays 260 x 210 x 80 mm 2 x Deep Trays halbaround 300 x 150 x 80 mm 4 x Deep Trays Triangle 350 x 260 x 50 mm</p>	<p>Round plate 780 x 780 mm (total 800 x 800 mm) from Slate look with stainless steel railing</p> <p>incl. 16-piece Deep Trays set; Series FRESH (black glossy -02): 4 x Deep Trays 260 x 210 x 80 mm 6 x Deep Trays 210 x 180 x 80 mm 2 x Deep Trays half around 300 x 150 x 80 mm 4 x Deep Trays Triangle 350 x 260 x 50 mm</p>



Dimensions in mm (L x W)	800 x 800
Deep Trays Height	80 mm
Item no.	RKO780/07-02
Price	€ 849,00
Consisting of	<p>Round plate 780 x 780 mm (total 800 x 800 mm) from Slate look with stainless steel railing</p> <p>incl. 17-piece Deep Tray Combi; Series FRESH (black glossy -02): 12 x Deep Trays 210 x 180 x 80 mm 2 x Deep Trays half around 300 x 150 x 80 mm 4 x Deep Trays Triangle 350 x 260 x 50 mm</p>

Prices plus VAT.

Trays and Deep Trays Series FRESH

Suitable for Rondell 800 x 800 mm



Dimensions in mm (L x W)	210 x 180 x 80	260 x 210 x 20	260 x 210 x 50	260 x 210 x 80
Volume	1.400 ml	-	1.700 ml	2.500 ml
Item no.	SAB210180-80	SAB260210-20	SAB260210-50	SAB260210-80
black glossy	-02 € 29,45	€ 25,95	€ 31,95	€ 31,95

Compatible Accessories:

Lid with Spoon Recess	-	-	-	-
transparent	-	-	-	-



Dimensions in mm (L x W)	350 x 260 x 50	300 x 150 x 80	300 x 300 x 50	300 x 300 x 80
Volume	1.400 ml	2.000 ml	2.500 ml	4.000 ml
Item no.	SAB350260-50	SAB300150-80	SAB300300-50	SAB300300-80
black glossy	-02 € 21,45	€ 31,95	€ 31,95	€ 32,95

Compatible Accessories:

Lid with Spoon Recess	-	ZDL300150-80-00	ZDL300150-50-00	ZDL300150-80-00
transparent	-	€ 21,95	€ 24,95	€ 24,95

Please add the color coding to the article number when ordering!

Prices plus VAT.

Circular Turntable Display Tray set ideal for Aichinger or Kramer counters

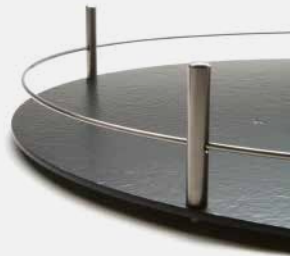

Designation	AICHINGER MaxxPoint Trays combination	KRAMER Round plate XXL	KRAMER Deep Trays combination
Maße	1.120 x 900 mm (incl. triangles)	1.070 x 1.070 mm	1.020 x 1.020 mm
Deep Trays Height	60 mm	ohne Schalen	60 mm
Item no.	RKP MP910-6-02	Thekenrondell XXL	RKS1070-60-02
Price	€ 749,00	€ 1.498,00	€ 599,00
Description	<p>18-piece-set 12 Stück 230 x 120 x 60 mm á 1.500 ml 4 Stück 220 x 290 x 60 mm á 1.600 ml 2 Stück 340 x 340 x 110 mm á 2.100 ml (Double glued) Dreiecke nicht enthalten</p> <p>Total capacity: 29.4 liters Plates: Ø 900 mm Bowl set: Ø 880 mm</p>	<p>- Stable swivel system - without support trays - Railing made of V4A (stainless steel with 6 bolts</p>	<p>14-piece-set 10 Stück 263 x 116 x 60 mm á 2.600 ml 4 Stück 245 x 245 x 60 mm á 2.200 ml</p> <p>Volume total: 32,4 Liter</p>

Prices plus VAT.



YOUR ADVANTAGES

- ✓ Rotatable Round Plate for easy and back-friendly operation
- ✓ Round Plate is especially resilient and stable
- ✓ High quality Slate look

Order online now!

Online-Shop

www.pricoplex.com

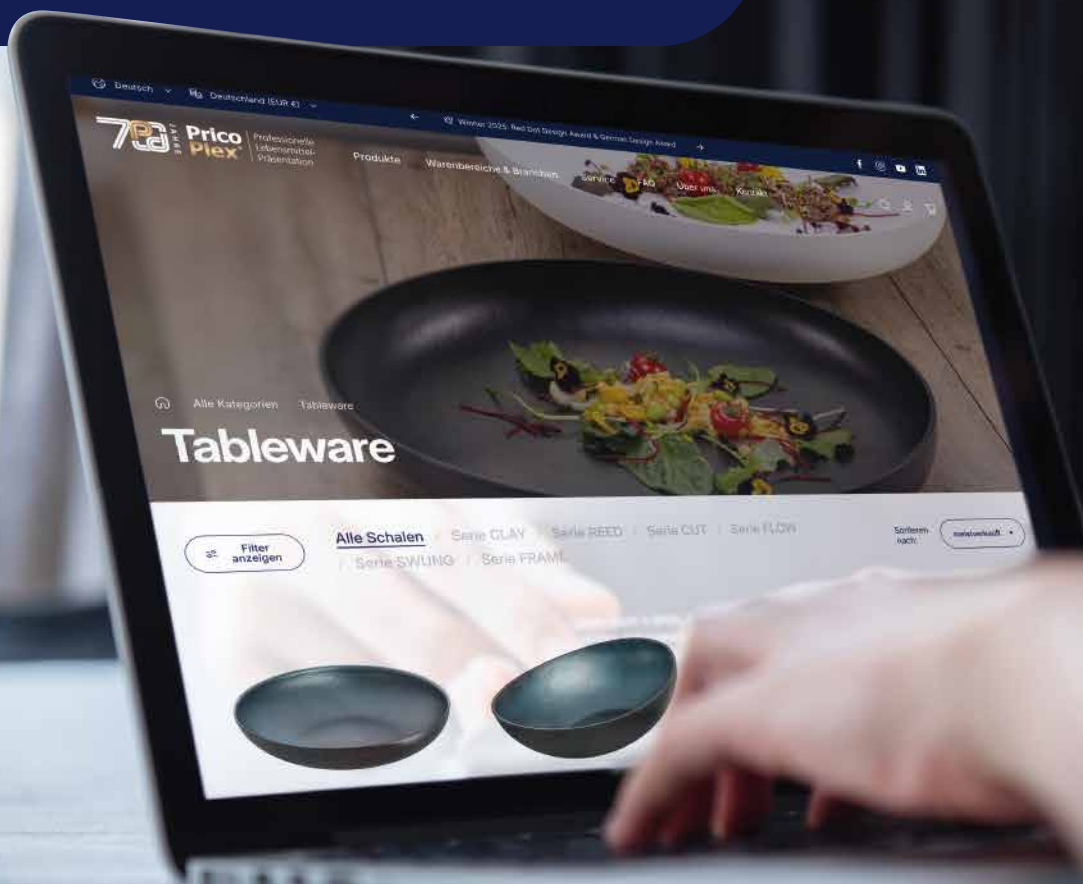

✓ Express shipping

✓ Sample order

✓ Online consulting

ORDER WITH SYSTEM

Deep Tray Combis and Angle Solutions



Deep Tray Combis

Orderly Presentation in the deli counter is crucial to your success. Make this task child's play: with ready-assembled Deep Tray Combinations that can be arranged in different groupings in no time at all. This is how easy counter design can be today!

YOUR ADVANTAGES

- ✓ Convertible Trays sets
- ✓ Alternating optics
- ✓ Variable Volume
- ✓ Glossy colors: 



Angle Solutions

Looking to get that extra edge in your display? Of course! Corner and angle solutions are perfect for making the presentation a center of attraction even in tricky corners and counter angles. With our system, every nook and cranny is utilized – while also allowing easy and seamless changeover of product.

YOUR ADVANTAGES

- ✓ Convertible corner and angle solutions for counter angles
- ✓ Variable Volumes
- ✓ Glossy colors: 







Use the full potential of your presentation space



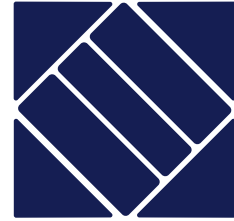
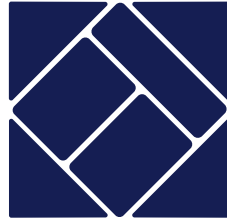
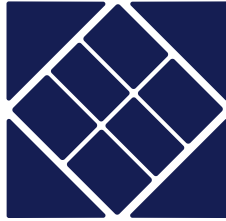



Interlocking Trays allow variable filling quantities

Deep Tray Combis

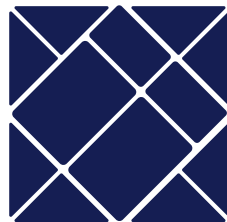

Designation	Deep Tray Combi 1009	Deep Tray Combi 1010	Deep Tray Combi 1011
Dimensions in mm (L x W x H)	800 x 800 x 50	800 x 800 x 50	800 x 800 x 50
Item no.	SKO1009	SKO1010	SKO1011
white glossy  -10	€ 229,95	€ 215,95	€ 209,95
black glossy  -02	€ 229,95	€ 215,95	€ 209,95
red glossy  -05	€ 229,95	-	-
Consisting of	10-piece Deep Tray Combi Series FRESH: 4 x deep Tray 265 x 200 x 50 mm 2 x Deep Trays 265 x 160 x 50 mm 4 x Deep Trays 580 x 420 x 50 mm	7-piece Deep Tray Combi Series FRESH: 2 x Deep Trays 400 x 265 x 50 mm 1 x Deep Trays 530 x 160 x 50 mm 4 x Deep Trays 580 x 420 x 50 mm	7-piece Deep Tray Combi Series FRESH: 2 x Deep Trays 530 x 200 x 50 mm 1 x Deep Trays 530 x 160 x 50 mm 4 x Deep Trays 580 x 420 x 50 mm







Designation	Deep Tray Combi 1012	Deep Tray Combi 1013	Deep Tray Combi 1014
Dimensions in mm (L x W x H)	800 x 800 x 50	800 x 800 x 50	800 x 800 x 50
Item no.	SKO1012	SKO1013	SKO1014
white glossy  -10	€ 274,95	€ 269,95	€ 249,95
black glossy  -02	€ 274,95	€ 269,95	€ 249,95
red glossy  -05	€ 274,95	€ 269,95	-
Consisting of	14-piece Deep Tray Combi Series FRESH: 4 x Deep Trays 265 x 200 x 50 mm 2 x Deep Trays 265 x 160 x 50 mm 8 x Deep Trays 350 x 260 x 50 mm	12-piece Deep Tray Combi Series FRESH: 2 x Deep Trays 400 x 265 x 50 mm 2 x Deep Trays 400 x 160 x 50 mm 8 x Deep Trays 350 x 260 x 50 mm	11-piece Deep Tray Combi Series FRESH: 2 x Deep Trays 530 x 200 x 50 mm 1 x Deep Trays 530 x 160 x 50 mm 8 x Deep Trays 350 x 260 x 50 mm

Please add the color coding to the article number when ordering!

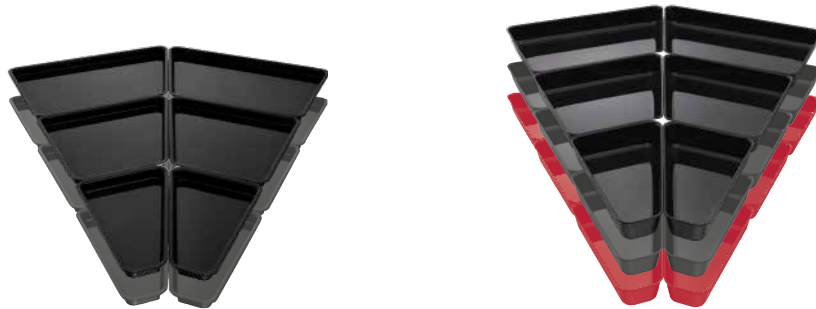
Prices plus VAT.

Angle Solutions



Dimensions in mm (LxWxH)	800 x 760/180 x 20 (angle 45°)	800 x 760/180 x 50 (angle 45°)
Volume total	–	13.200 ml
Item no.	ELO80045-20	ELO80045-50
black glossy	 -02 € 189,95	€ 189,95
stone graphit	 -25 € 219,95	€ 219,95
red glossy	 -05 –	€ 199,95
Consisting of	6-piece Plate set; Series FRESH in glossy	6-piece Deep Tray Combi; Series FRESH in glossy

Please add the color coding to the article number when ordering!

Prices plus VAT.

Your counter has a unique angle? We can manufacture a custom-fit, small-batch series for you.

We will be happy to advise you.

Phone at:

+49 (0) 81 93 – 23 69 80

Mail to:



office@pricoplex.com

Small-batch series produced individually according to customer specifications, suitable for your counter.



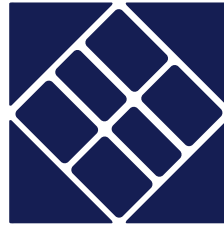
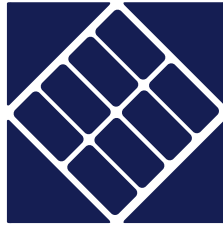

Deep Tray Combis



Designation	Deep Tray Combi 1001	Deep Tray Combi 1002	Deep Tray Combi 1003
Dimensions in mm (L x W x H)	840 x 840 x 50	840 x 840 x 50	840 x 840 x 50
Item no.	SKO1001	SKO1002	SKO1003
white glossy  -10	€ 265,95	€ 232,95	€ 214,95
black glossy  -02	€ 265,95	€ 232,95	€ 214,95
red glossy  -05	€ 265,95	€ 232,95	–
Consisting of	12-piece Deep Tray Combi Series FRESH: 8 x Deep Trays 280 x 140 x 50 mm 4 x Deep Trays 580 x 420 x 50 mm	10-piece Deep Tray Combi Series FRESH: 2 x Deep Trays 280 x 140 x 50 mm 4 x Deep Trays 280 x 210 x 50 mm 4 x Deep Trays 580 x 420 x 50 mm	8-piece Deep Tray Combi Series FRESH: 4 x Deep Trays 280 x 280 x 50 mm 4 x Deep Trays 580 x 420 x 50 mm



Designation	Deep Tray Combi 1004	Deep Tray Combi 1005	Deep Tray Combi 1006
Dimensions in mm (L x W x H)	840 x 840 x 50	840 x 840 x 50	840 x 840 x 50
Item no.	SKO1004	SKO1005	SKO1006
white glossy  -10	€ 219,95	€ 294,95	€ 259,95
black glossy  -02	€ 219,95	€ 294,95	€ 259,95
red glossy  -05	–	€ 304,95	€ 269,95
Consisting of	10-piece Deep Tray Combi Series FRESH: 6 x Deep Trays 280 x 190 x 50 mm 4 x Deep Trays 580 x 420 x 50 mm	16-piece Deep Tray Combi Series FRESH: 8 x Deep Trays 280 x 140 x 50 mm 8 x Deep Trays 350 x 260 x 50 mm	14-piece Deep Tray Combi Series FRESH: 2 x Deep Trays 280 x 140 x 50 mm 4 x Deep Trays 280 x 210 x 50 mm 8 x Deep Trays 350 x 260 x 50 mm

Please add the color coding to the article number when ordering!

Prices plus VAT.

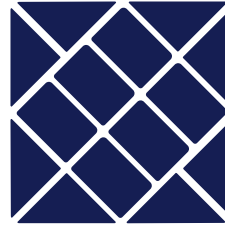
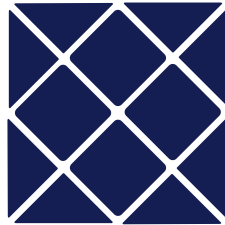

Designation	Deep Tray Combi 1007	Deep Tray Combi 1008
Dimensions in mm (LxWxH)	840 x 840 x 50	840 x 840 x 50
Item no.	SKO1007	SKO1008
white glossy	0 -10 € 249,95	€ 278,95
black glossy	1 -02 € 249,95	€ 278,95
Consisting of	12-piece Deep Tray Combi Series FRESH: 4 x Deep Trays 280 x 280 x 50 mm 8 x Deep Trays 350 x 260 x 50 mm	14-piece Deep Tray Combi Series FRESH: 6 x Deep Trays 280 x 190 x 50 mm 8 x Deep Trays 350 x 260 x 50 mm

Angle Solutions

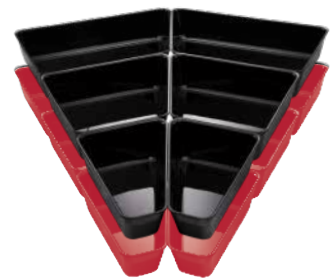

Dimensions in mm (LxWxH)	840 x 770/140 x 20 (angle 45°)	840 x 770/140 x 50 (angle 45°)	840 x 770/140 x 80 (angle 45°)
Deep Trays Height	20 mm	50 mm	80 mm
Item no.	ELO84045-20	ELO84045-50	ELO84045-80
black glossy	1 -02 € 189,95	€ 189,95	€ 225,95
red glossy	2 -05 -	-	€ 239,95
Consisting of	6-piece Deep Tray Combi; Series FRESH in glossy	6-piece Deep Tray Combi; Series FRESH in glossy	6-piece Deep Tray Combi; Series FRESH in glossy

Please add the color coding to the article number when ordering!

Prices plus VAT.

BASIC EQUIPMENT IN ELEGANCE

Decor Panels and Inserts

for Stepped Displays
and Counter floors

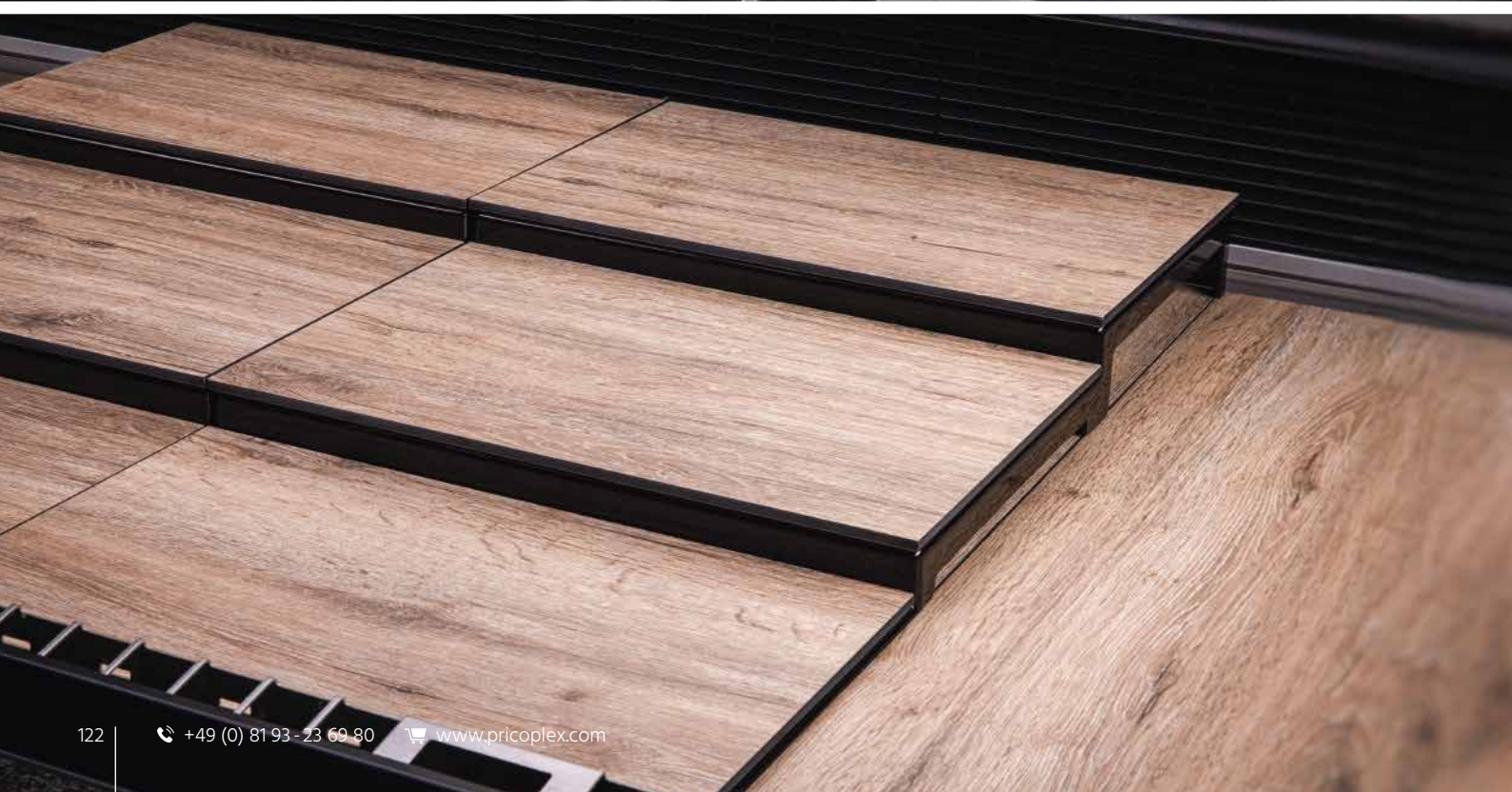

Create beautiful bases in an instant – on the counter floor, on the Layered Displays, under Trays, etc. – ideal for seasonal specialties, daily delicacies, themed areas, the snack and snack area, the home cooking corner ...

YOUR ADVANTAGES

- ✓ For beautiful visual accents
- ✓ Particularly natural look
- ✓ Can be customized using laser technology
- ✓ In high-quality Slate or Wood look



High quality Wood look with juice groove



Wood look with individual Branding through laser technology



Optionally with anti-slip foot studs incl. holes



TIPS & TRICKS

Selectively highlight merchandise on engraved plates to attract attention and inform customers while they wait, saving valuable time. Other information can be presented with clear displays directly on the merchandise.

Decor Panels and Inserts

optional with foot studs



Dimensions in mm (L x W x H)		200 x 265 x 6	265 x 200 x 6	400 x 265 x 6	820 x 200 x 6	820 x 400 x 6
Item no.		ST200265	ST265200	ST400265	ST820200	ST820400
Slate look	 -82	€ 19,95	€ 19,95	€ 44,95	€ 69,95	€ 89,95
Wood look	 -85	€ 19,95	€ 19,95	€ 44,95	€ 69,95	€ 89,95

Customization at extra cost:

with individual branding (Add'l € 95,00)*	-	-	€ 19,95	€ 19,95	€ 19,95
and juice groove	-	-	€ 19,95	€ 19,95	€ 19,95

With anti-slip foot studs incl. holes at extra costs:

Total Height 15 mm	-FS9	-	-	€ 14,95 (4 foot studs)	€ 19,95 (6 foot studs)	€ 19,95 (6 foot studs)
Total Height 30 mm	-FS24	-	-	€ 16,95 (4 foot studs)	€ 21,95 (6 foot studs)	€ 21,95 (6 foot studs)
Total Height 40 mm	-FS34	-	-	€ 18,95 (4 foot studs)	€ 23,95 (6 foot studs)	€ 23,95 (6 foot studs)
Total Height 50 mm	-FS44	-	-	€ 20,95 (4 foot studs)	€ 25,95 (6 foot studs)	€ 25,95 (6 foot studs)
Total Height 60 mm	-FS54	-	-	€ 22,95 (4 foot studs)	€ 27,95 (6 foot studs)	€ 27,95 (6 foot studs)
Total Height 70 mm	-FS64	-	-	€ 24,95 (4 foot studs)	€ 29,95 (6 foot studs)	€ 29,95 (6 foot studs)
Total Height 80 mm	-FS74	-	-	€ 26,95 (4 foot studs)	€ 31,95 (6 foot studs)	€ 31,95 (6 foot studs)

Please add the coding for color/footstudHeight to article no. when ordering!



Prices plus VAT.

***Branding:** There is a one-time cost of plus € 95,00 for setting up the branding motif.

Decor Panels and Inserts

optional with foot studs



Dimensions in mm (L x W x H)	210 x 280 x 6	280 x 210 x 6	420 x 280 x 6	840 x 210 x 6	840 x 420 mm
Item no.	ST210280	ST280210	ST420280	ST840210	ST840420
Slate look  -82	€ 21,95	€ 21,95	€ 47,95	€ 74,95	€ 94,95
Wood look  -85	€ 21,95	€ 21,95	€ 47,95	€ 74,95	€ 94,95

Customization at extra cost:

with individual branding (Add'l € 95,00)*	-	-	€ 19,95	€ 19,95	€ 19,95
and juice groove	-	-	€ 19,95	€ 19,95	€ 19,95

With anti-slip foot studs incl. holes at extra costs:

Total Height 15 mm	-FS09	-	-	€ 14,95 (4 foot studs)	€ 19,95 (6 foot studs)	€ 19,95 (6 foot studs)
Total Height 30 mm	-FS24	-	-	€ 16,95 (4 foot studs)	€ 21,95 (6 foot studs)	€ 21,95 (6 foot studs)
Total Height 40 mm	-FS34	-	-	€ 18,95 (4 foot studs)	€ 23,95 (6 foot studs)	€ 23,95 (6 foot studs)
Total Height 50 mm	-FS44	-	-	€ 20,95 (4 foot studs)	€ 25,95 (6 foot studs)	€ 25,95 (6 foot studs)
Total Height 60 mm	-FS54	-	-	€ 22,95 (4 foot studs)	€ 27,95 (6 foot studs)	€ 27,95 (6 foot studs)
Total Height 70 mm	-FS64	-	-	€ 24,95 (4 foot studs)	€ 29,95 (6 foot studs)	€ 29,95 (6 foot studs)
Total Height 80 mm	-FS74	-	-	€ 26,95 (4 foot studs)	€ 31,95 (6 foot studs)	€ 31,95 (6 foot studs)

Please add the coding for color/footstudHeight to article no. when ordering!

Prices plus VAT.

***Branding:** There is a one-time cost of plus € 95.00 for setting up the branding motif.

Decor Panels and inserts

optional with foot studs



Dimensions in mm (L x W x H)		220 x 290 x 6	290 x 220 x 6	440 x 290 x 6	870 x 220 x 6	870 x 440 x 6
Item no.		ST200290	ST290220	ST440290	ST870220	ST870440
Slate look	-82	€ 21,95	€ 21,95	€ 49,95	€ 79,95	€ 99,95
Wood look	-85	€ 21,95	€ 21,95	€ 49,95	€ 79,95	€ 99,95

Customization at extra cost:

with individual branding (Add'l € 95,00)*	-	-	€ 19,95	€ 19,95	€ 19,95
and juice groove	-	-	€ 19,95	€ 19,95	€ 19,95

With anti-slip foot studs incl. holes at extra costs:

Total Height 15 mm	-FS9	-	-	€ 14,95 (4 foot studs)	€ 19,95 (6 foot studs)	€ 19,95 (6 foot studs)
Total Height 30 mm	-FS24	-	-	€ 16,95 (4 foot studs)	€ 21,95 (6 foot studs)	€ 21,95 (6 foot studs)
Total Height 40 mm	-FS34	-	-	€ 18,95 (4 foot studs)	€ 23,95 (6 foot studs)	€ 23,95 (6 foot studs)
Total Height 50 mm	-FS44	-	-	€ 20,95 (4 foot studs)	€ 25,95 (6 foot studs)	€ 25,95 (6 foot studs)
Total Height 60 mm	-FS54	-	-	€ 22,95 (4 foot studs)	€ 27,95 (6 foot studs)	€ 27,95 (6 foot studs)
Total Height 70 mm	-FS64	-	-	€ 24,95 (4 foot studs)	€ 29,95 (6 foot studs)	€ 29,95 (6 foot studs)
Total Height 80 mm	-FS74	-	-	€ 26,95 (4 foot studs)	€ 31,95 (6 foot studs)	€ 31,95 (6 foot studs)

Please add the coding for color/footstudHeight to article no. when ordering!

Prices plus VAT.

***Branding:** There is a one-time cost of plus € 95,00 for setting up the branding motif.

Custom-made

You wish for other dimensions or a specific angle? We make it possible and are happy to advise you.

Phone at:

+49 (0) 81 93 – 23 69 80

Mail at:

office@pricoplex.com



FOR MORE PRESENTATION SPACE

Counter Tops

with Compatible Accessories



For that special something in your display: the popular Counter Top creates an additional presentation area – highly visible, within reach and top-hygienic. Now in a new design: made of impact-resistant polycarbonate and mounted with stainless steel screws. Body and side walls have a reduced material thickness – the countertop is easier to move and handle. Integrated rubber feet guarantee a firm surface grip. Offering excellent ventilation and easy cleaning.



YOUR ADVANTAGES

- ✓ Very stable thanks to high material strength
- ✓ Increases customer attention
- ✓ Even sturdier construction thanks to the screw connectors
- ✓ Easy cleaning thanks to side openings
- ✓ With side vents

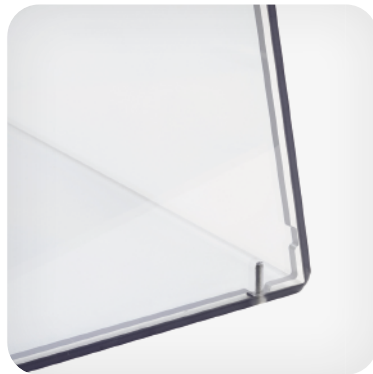

COMPATIBLE ACCESSORIES

Display Trays different Series

- ✓ Creates high quality focal points
- ✓ For easy removal of goods
- ✓ Fits exactly into the Counter Tops



Decorative Panels in Wood and Slate look

- ✓ For beautiful visual accents
- ✓ Particularly natural look
- ✓ Can be customized using laser technology
- ✓ Slate and Wood look: 



Counter Tops

with Compatible Accessories



Dimensions in mm (LxWxH)	445 x 265 x 210	445 x 265 x 210 with false bottom
Material	Polycarbonate	Polycarbonate
Item no.	TAS445	TAS445/2
transparent	€ 189,95	€ 249,95
Compatible Accessories:		
Display Trays		
Option 1	2 Piece 280 x 210 x 20 mm	2 Piece 280 x 210 x 20 mm
Option 2	1 Piece 420 x 280 x 20 mm	1 Piece 420 x 280 x 20 mm
Decor plate		
	ST420250	ST420250
Slate look	-82 € 34,95	€ 34,95
Wood look	-85 € 34,95	€ 34,95

Please add the color coding to the article number when ordering!



Prices plus VAT.





Dimensions in mm (LxWxH)	655 x 265 x 210	865 x 265 x 210
Material	Polycarbonate	Polycarbonate
Item no.	TAS655	TAS865
transparent	€ 219,95	€ 249,95

Compatible Accessories:

Display Trays		
Option 1	3 Piece 280 x 210 x 20 mm	4 Piece 280 x 210 x 20 mm
Option 2	1 Piece 420 x 280 x 20 mm 1 Piece 280 x 210 x 20 mm	2 Piece 420 x 280 x 20 mm
Decor plate	ST630250	ST840250
Slate look  -82	€ 49,95	€ 69,95
Wood look  -85	€ 49,95	€ 69,95

Please add the color coding to the article number when ordering!

Prices plus VAT.

EXPERT TIP



Peter Schneider
PricoPlex
Customer Consultant

Create culinary gems on and next to the counter: Counter Tops are ideal for goods that do not require refrigeration, and create an area to place additional sales or offers. Cases are also ideal to offer a tasting, e.g. with our tasting plate (see Page 133).

CLEVER ADDITIONS

Counter Accessories

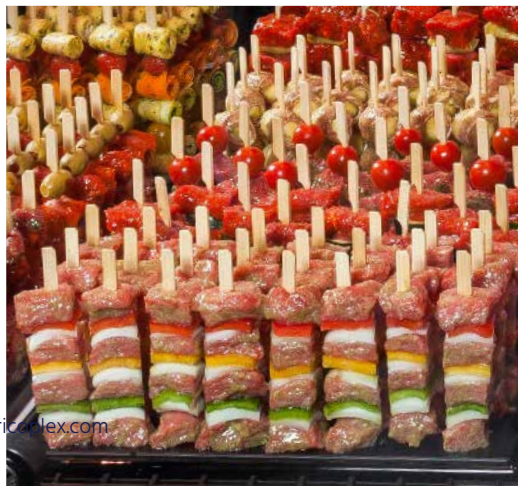
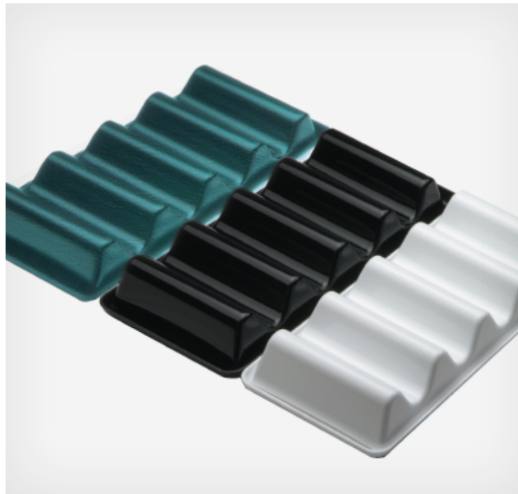



Slotted / Antipasti Spoon € 3,35
 Length: 260 mm
 Material: plastic
 Packaging unit: 6 pieces

■ black	ALO260-02
□ white	ALO260-10
□ transparent	ALO260-00



Delicatessen spoon € 2,50
 Length: 235 mm
 Material: plastic
 Packaging unit: 6 pieces

■ black	LOE235-02
□ white	LOE235-10
□ transparent	LOE235-00



Small Scoop € 3,05
 Length: 250 mm
 Material: Plastic

■ black SCH250-02



Large Scoop € 4,45
 Length: 310 mm
 Material: Plastic

■ black SCH310-02



Salad / Delicatessen tongs € 5,45
 Length: 300 mm
 Material: Plastic

■ black	ZA300-02
□ white	ZA300-10
□ transparent	ZA300-00



Cream cheese / minced meat knife € 11,45
 Blade length: 160 mm
 Total length: 270 mm
 Material: Plastic

■ black	KS268-02
□ white	KS268-10
■ green	KS268-04
□ transparent	KS268-00



Price holder small € 6,65
 72 mm
 Material: Plastic
 Packaging unit: 10 pieces

□ transparent PCL400144-00



Price holder large € 6,65
 130 mm
 Material: Plastic
 Packaging unit: 10 pieces

□ transparent PCL400185-00



Price holder € 2,95
 for cards (H x W x D)
 80 x 50 x 45 mm
 Material: Plastic
 Packaging unit: 10 pieces

□ transparent PCL400104-00



Deep Trays clip short € 2,95
 for clipping to bowls
 plug width 55 mm
 Material: Plastic
 Packaging unit: 25 pieces

□ transparent PCL72-00



Deep Trays clip long € 3,45
 for clipping to bowls
 plug width 55 mm
 Material: Plastic
 Packaging unit: 25 pieces

□ transparent PCL130-00



Card holder Set of 4 € 29,95
 Set of 4; Ø 5 cm, H: 10,5 cm incl. 20 black Labeling cards, 10 x 6 cm each
 Material: Stainless steel Gunmetal

Kartenhalter Set 10,5



Tasting plate small € 56,95
 Base area: 230 x 230 mm + Handle length 120 mm incl. Lid

Slate look VKT230230-82



Tasting plate large € 75,90
 Base area: 300 x 300 mm + Handle length 120 mm incl. Lid

Slate look VKT300300-82



Control tablet € 37,95
 Serving tray for hygienic, packaging-free selling
 460 x 340 x 80 mm
 Material: Impact resistant plastic

■ black glossy BDT460340-8-22

Counter Accessories



Buffet plate Ø 200 mm

Material: Plastic in Slate look

	Slate look	Wood look	
15 mm Height	BFT200-15-82	BFT200-15-85	€ 49,95
30 mm Height	BFT200-30-82	BFT200-30-85	€ 50,95
40 mm Height	BFT200-40-82	BFT200-40-85	€ 51,95
50 mm Height	BFT200-50-82	BFT200-50-85	€ 52,95
60 mm Height	BFT200-60-82	BFT200-60-85	€ 53,95
80 mm Height	BFT200-80-82	BFT200-80-85	€ 54,95



Buffet plate Ø 300 mm

Material: Plastic in Slate look

	Slate look	Wood look	
15 mm Height	BFT300-15-82	BFT300-15-85	€ 54,95
30 mm Height	BFT300-30-82	BFT300-30-85	€ 55,95
40 mm Height	BFT300-40-82	BFT300-40-85	€ 56,95
50 mm Height	BFT300-50-82	BFT300-50-85	€ 57,95
60 mm Height	BFT300-60-82	BFT300-60-85	€ 58,95
80 mm Height	BFT300-80-82	BFT300-80-85	€ 59,95



Snack Wave Displays

390 x 180 x 60 mm

Material: Impact resistant plastic

black	SW380160-60-02	€ 21,45
white	SW380160-60-10	€ 21,45



Cutting board with Stop bar

€ 69,95

500 x 300 x 20 mm
Material: PE500

white	SBT500300-10
blue	SBT500300-03
green	SBT500300-04
red	SBT500300-05
yellow	SBT500300-06

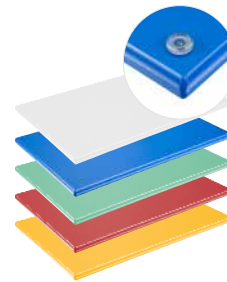

Cutting board with rubber feet

€ 59,95

500 x 300 x 20 mm
Material: PE500

white	SB500300-10
blue	SB500300-03
green	SB500300-04
red	SB500300-05
yellow	SB500300-06

Spit holder

for insertion into Display Trays or Deep Trays
Material: PE500, black

245 x 175 x 20 20 skewers in 4 rows	SPH280210-02	€ 20,95
235 x 165 x 20 mm 20 skewers in 4 rows	SPH265200-02	€ 20,95



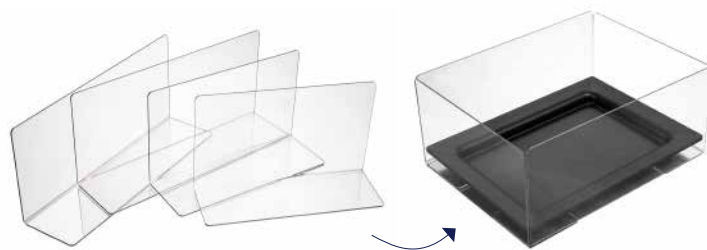

Meet hygiene requirements using our simple, practical system!

SY 8.0

Panel Divider System

Set for 265 x 200 mm € 47,95

Set of 4 for Trays and Deep Trays; suitable for Modular System 8.0; L-shape
Material: Polycarbonate

transparent TSS2652005-00

SY 8.0

Panel Divider System

Set for 400 x 265 mm € 55,95

Set of 4 for Trays and Deep Trays; suitable for Modular system 8.0; L-shape
Material: Polycarbonate

transparent TSS400265-00

SY 8.4

Panel Divider System

Set for 280 x 210 mm € 47,95

Set of 4 for Trays and Deep Trays; suitable for Modular system 8.4; L-shape
Material: Polycarbonate

transparent TSS280210-00

SY 8.4

Panel Divider System

Set for 420 x 280 mm € 55,95

Set of 4 for Trays and Deep Trays; suitable for Modular system 8.4; L-shape
Material: Polycarbonate

transparent TSS420280-00



Merchandise display €€ 59,95

625 x 210 x 70 mm
black with ventilation slots
Material: Plastic

black WBT625210-70-02

Merchandise display, Set of 4 with Dividers

€ 254,95

Consisting of 4 product carriers and 4 dividers
black with ventilation slots
Material: plastic

630 x 760 x 105 mm (LxWxH)
WBT-MK5-630760-105

630 x 690 x 105 mm (LxWxH)
WBT-MK5-630690-105

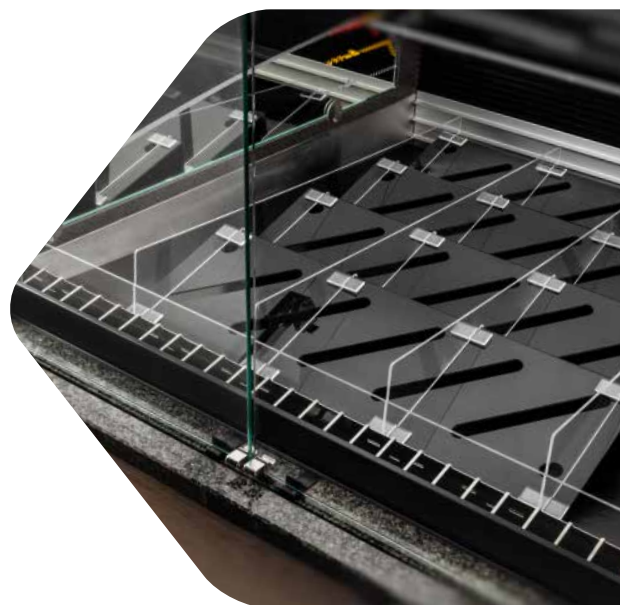

Salads, snacks to go, and more are brought closer to the customer's line of sight.

The divider system allows you to meet hygiene requirements in a flexible way.



General terms and conditions

§ 1 Geltungsbereich

- Die nachstehenden Allgemeinen Geschäftsbedingungen gelten ausschließlich für Verkäufe von Waren und sonstige Leistungen durch uns, PricoPlex GmbH, gleich ob diese Geschäfte online oder offline abgeschlossen werden. Es gelten die nachstehenden Allgemeinen Geschäftsbedingungen in ihrer jeweils im Zeitpunkt des Vertragsschlusses gültigen Fassung. Davon abweichende oder entgegenstehende Bedingungen der Käufer werden von uns nicht anerkannt, sofern diese nicht ausdrücklich zwischen PricoPlex GmbH und dem Kunden schriftlich vereinbart worden sind. Die Durchführung der Leistungen ist nicht als eine solche Zustimmung zu werten.
- Die vorliegenden Allgemeinen Geschäftsbedingungen gelten ausschließlich gegenüber Unternehmern iSd § 14, 310 Abs.1 BGB.

§ 2 Vertragsschluss

- Wir verkaufen unsere Waren und sonstigen Leistungen ausschließlich an Unternehmer iSd § 14 BGB.
- Bei Aufträgen, die im elektronischen Geschäftsverkehr (E-Mail, Telefax, Telefon, Online-Shop) abgegeben werden, bestätigt PricoPlex GmbH den Zugang des Angebotes unverzüglich auf elektronischem Wege.
- PricoPlex GmbH ist berechtigt, das Angebot des Kunden innerhalb eines Zeitraumes von 7 Kalendertagen durch Übermittlung einer Auftragsbestätigung anzunehmen. Die Auftragsbestätigung kann insbesondere auch durch Übermittlung einer E-Mail erfolgen. Nach fruchtlosem Fristablauf gilt das Angebot als abgelehnt.

§ 3 Preise und Zahlungsbedingungen

- Alle Preise verstehen sich ausschließlich der jeweils gesetzlich gültigen Mehrwertsteuer ab Betriebsstz von PricoPlex GmbH. Kosten für Transporte, Verpackung oder Versicherung werden gesondert berechnet.
- Zahlungen erfolgen entweder per Nachnahme oder gegen Vorkasse. Bestellungen aus dem Ausland werden nur gegen Vorkasse angenommen und abgewickelt.

§ 4 Leistungspflicht, Lieferbedingungen, Lieferverzögerungen, Annahmeverzug

- Erfüllungsort ist der Geschäftssitz von PricoPlex GmbH.
- PricoPlex GmbH bemüht sich um schnellstmögliche Lieferung. PricoPlex GmbH ist zu Teillieferungen berechtigt, sofern die Teillieferung dem Besteller im Einzelfall zumutbar ist.
- Unsere Leistungspflicht beschränkt sich bis zur Übergabe der Ware(n) an das Versand- bzw. Transportunternehmen auf den in unserem Lager verfügbaren Vorrat von Waren des gleichen Typs und der gleichen Designation. Eine Beschaffungspflicht besteht darüber hinaus nicht.
- Jede Lieferung steht unter dem Vorbehalt, dass PricoPlex GmbH selbst rechtzeitig und ordnungsgemäß beliefert wird. Wird PricoPlex GmbH selbst nicht beliefert, obwohl PricoPlex GmbH bei zuverlässigen Lieferanten deckungsgleiche Bestellungen aufgegeben hat, wird PricoPlex GmbH von der Leistungspflicht frei und kann vom Vertrag zurücktreten. PricoPlex GmbH ist verpflichtet, den Kunden über die Nichtverfügbarkeit der Leistung unverzüglich zu unterrichten, und wird jede schon erbrachte Gegenleistung des Kunden unverzüglich erstatten.
- Wird die Ware auf Wunsch des Bestellers an diesen versandt, so geht mit der Absendung

an den Besteller, spätestens mit Verlassen der Geschäftsräume von PricoPlex GmbH die Gefahr des zufälligen Untergangs oder der zufälligen Verschlechterung der Ware auf den Besteller über. Dies gilt unabhängig davon, ob die Versendung der Ware vom Erfüllungsort erfolgt oder wer die Frachtkosten trägt.

§ 5 Gewährleistung, Beschaffenheit der Waren

- Wir bemühen uns immer, die Angaben zu unseren Produkten und deren Abbildung mit größtmöglicher Sorgfalt und Korrektheit zu leisten. Soweit der Besteller von uns doch einmal mangelhafte Ware erhalten hat, ist er im Rahmen der gesetzlichen Gewährleistungsbestimmungen berechtigt, Nacherfüllung zu verlangen, vom Vertrag zurückzutreten oder den Kaufpreis zu mindern, vorausgesetzt der Besteller ist seinen nach § 377 HGB geschuldeten Untersuchungs- und Rügeobliegenheiten ordnungsgemäß nachgekommen. Hierzu hat der Kunde die Ware unverzüglich auf Mängel und Beschaffenheit zu untersuchen und im Falle von offensichtlichen Mängeln, innerhalb von 10 Tagen anzuzeigen. Werden Waren mit offensichtlichen Schäden an der Verpackung oder am Inhalt angeliefert, so hat der Kunde dies sofort beim Spediteur/Frachtdienst zu reklamieren und die Annahme zu verweigern. Zudem ist unverzüglich mit PricoPlex GmbH unter Anzeige der Schäden Kontakt aufzunehmen. Des Weiteren können dem Käufer Schadensersatzansprüche zustehen.
- Mängelansprüche bestehen nicht bei nur unerheblicher Abweichung von der vereinbarten Beschaffenheit, bei nur unerheblicher Beeinträchtigung der Brauchbarkeit, bei natürlicher Abnutzung oder Verschleiß wie bei Schäden, die nach dem Gefahrübergang infolge fehlerhafter oder nachlässiger Behandlung, übermäßiger Beanspruchung, ungeeigneter Betriebsmittel, oder aufgrund besonderer äußerer Einflüsse entstehen, die nach dem Vertrag nicht vorausgesetzt sind.
- Sofern im Rahmen der gesetzlichen Gewährleistung ein Rückgabeanspruch besteht, ist der Besteller gegenüber PricoPlex GmbH zum Ersatz der Wertminderung oder des entstandenen Schadens verpflichtet, wenn der Kunde die Verschlechterung, den Untergang oder eine anderweitige Unmöglichkeit der Rückgabe der Ware zu vertreten hat. Eine Verschlechterung der Ware ist vor allem auch dann gegeben, wenn Accessories fehlt oder die Ware nicht in unbeschädigter Originalverpackung zurückgeschickt wird. All dies gilt nicht, wenn die Verschlechterung ausschließlich auf deren Prüfung - wie sie etwa im Ladengeschäft möglich ist - zurückzuführen ist. Im Übrigen kann die Wertersatzpflicht vermieden werden, indem die Sache vom Kunden nicht wie von einem Eigentümer in Gebrauch genommen wird und dieser alles unterlässt, was deren Wert beeinträchtigt. Eine Rückgabe ist ausgeschlossen bei der Lieferung von Waren, die nach Kundenspezifikation angefertigt werden oder eindeutig auf die persönlichen Bedürfnisse zugeschnitten sind oder die aufgrund ihrer Beschaffenheit nicht für eine Rücksendung geeignet sind.
- Hat der Kunde die Ware nicht abgenommen und schuldet er deswegen Schadenersatz, so hat er 20% des Kaufpreises (ohne Mehrwertsteuer) als paubowls Schadenersatz zu bezahlen, ohne dass es eines besonderen Nachweises bedarf, sofern er nicht einen geringeren Schaden nachweist.
- Die Verjährungsfrist für Mängelansprüche beträgt 12 Monate gerechnet ab Gefahrübergang. Hiervon ausgenommen sind Schadensersatzansprüche wegen der Verletzung von Leben, Körper oder

Gesundheit und/oder Schadensersatzansprüche aufgrund von grob fahrlässig oder vorsätzlich verursachten Schäden durch PricoPlex GmbH. Insoweit gelten die gesetzlichen Verjährungsfristen.

§ 6 Eigentumsvorbehalt

- Wir behalten uns das Eigentum an der gelieferten Sache bis zur vollständigen Zahlung sämtlicher Forderungen aus der Geschäftsbeziehung mit dem Besteller vor. Dies gilt auch für alle zukünftigen Lieferungen, auch wenn wir uns nicht stets ausdrücklich hierauf berufen. Während dieser Zeit dürfen die Gegenstände weder weiter veräußert, vermietet, verliehen oder verschenkt, noch innerhalb der Gewährleistungspflicht bei Dritten in Reparatur gegeben werden.
- Bei vertragswidrigem Verhalten des Bestellers, insbesondere bei Zahlungsverzug, sind wir berechtigt, die Kaufsache zurückzunehmen.

§ 7 Aufrechnung

- Eine Aufrechnung mit Ansprüchen von PricoPlex GmbH ist seitens des Kunden nur zulässig, wenn seine Gegenansprüche rechtskräftig festgestellt oder von PricoPlex GmbH anerkannt worden sind.

§ 8 Datenspeicherung

- Gemäß § 28 des Bundesdatenschutzgesetzes wird darauf aufmerksam gemacht, dass die im Rahmen der Geschäftsabwicklung notwendigen Daten mittels einer EDV-Anlage gemäß § 33 Bundesdatenschutzgesetz erarbeitet und gespeichert werden. Persönliche Daten werden vertraulich behandelt. Sollte der Kunde Änderungen, Sperrungen oder Löschungen seiner Daten wünschen, hat er sich zu wenden an

PricoPlex GmbH, Am Mittelfeld 11, 86922 Eresing – Deutschland

§ 9 Schlussbestimmungen, anwendbares Recht, Gerichtszuständigkeit, salvatorische Klausel

- Änderungen oder Ergänzungen dieser Geschäftsbedingungen bedürfen der Schriftform. Dies gilt auch für die Aufhebung dieses Schriftformerfordernisses.
- Ist der Käufer Kaufmann, eine juristische Person des öffentlichen Rechts oder ein öffentlich-rechtliche Sondervermögen, ist ausschließlicher Gerichtsstand und Erfüllungsort unser Geschäftssitz.
- In allen übrigen, vorliegend nicht geregelten Fällen richtet sich der Gerichtsstand nach den gesetzlichen Vorschriften.
- Sollten einzelne Bestimmungen dieses Vertrages unwirksam sein oder den gesetzlichen Regelungen widersprechen, so wird hierdurch der Vertrag im Übrigen nicht berührt.
- Die Geltung des UN-Kaufrechts (CISG) wird ausgeschlossen. Es gilt deutsches Recht.
- Die Rechte des Kunden aus diesem Vertrag sind nicht übertragbar.
- Sollten eine oder mehrere Regelungen dieser Allgemeinen Geschäftsbedingungen unwirksam sein, so zieht dies nicht die Unwirksamkeit der totalen Allgemeinen Geschäftsbedingungen nach sich. Die unwirksame Regelung wird durch die einschlägige gesetzliche Regelung ersetzt.
- Die Geltung des UN-Kaufrechts (CISG) wird ausgeschlossen. Es gilt deutsches Recht.

Stand: 01/2026

COMPANY

SURNAME

FIRST NAME

STREET, NO.

POSTAL CODE, CITY

PHONE NUMBER

FAX

E-MAIL

CUSTOMER NO. (IF AVAILABLE)

Payment Method

- per invoice
- by direct debit

ACCOUNT HOLDER

IBAN

BIC

CITY, DATE

SIGNATURE

SPACE FOR COMMENTS, NOTES OR SKETCHES

SERVICE

Personal advice



EXPRESS SHIPPING

Take advantage of our express shipping: With around 15,000 products in stock on-site, our main range is quickly available for you – so if your opening or event is just around the corner, your desired products can be with you within one day.

If you order before 12 noon, you can receive your package the next morning, provided that the products are available in stock. We will be happy to inform you personally about all modalities in this regard.



PRODUCT SAMPLE REQUEST

Just try it out – because not all plastics are the same. Our break-resistant materials and our unique range of surfaces are noticeably different.

Request a sample shipment: See for yourself and order product samples to choose from. This gives you the opportunity to take a close look at our materials in advance.



We will be happy to support you in your decision: Contact us for a consultation.

Call us



+49 (0) 81 93 – 23 69 80

Write us an e-mail



office@pricoplex.com

Book a consultation appointment



Simply scan via smartphone and choose an available appointment!

Send fax



+49 (0) 81 93 – 236 98 20

Follow us

 **facebook** /pricoplex

 **LinkedIn** /pricoplex

 **instagram** /pricoplex

 **youtube** /@PricoPlexGmbH





Price changes, technical modifications and errors excepted.
As of 02/2025. Copyright and reproduction only with written
permission of PricoPlex GmbH.

PricoPlex GmbH
Am Mittelfeld 11
86922 Eresing
Germany

Phone +49 (0) 81 93 / 23 69 8 - 0
Fax +49 (0) 81 93 / 23 69 8 - 20
Mail office@pricoplex.com

www.pricoplex.com